

# Crystalfontz America, Incorporated

## USB LCD MODULE SPECIFICATIONS

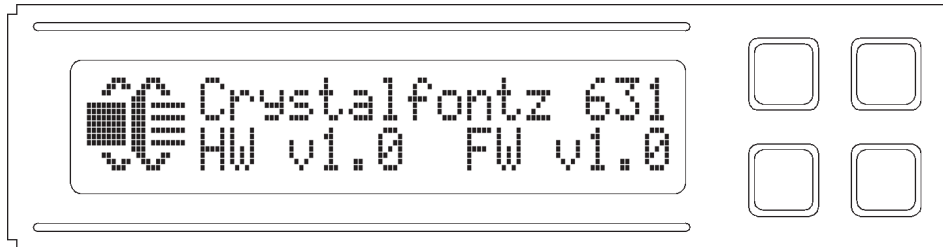

<b>Crystalfontz Model Number</b>	<b>CFA631-RMF-KU</b>
<b>Hardware Version</b>	<b>v2.0 August 2005</b>
<b>Firmware Version</b>	<b>v2.0 August 2005</b>
<b>Data Sheet Version</b>	<b>v2.0a December 2005</b>
<b>Product Pages</b>	<a href="http://www.crystalfontz.com/products/631">www.crystalfontz.com/products/631</a>

<b>Customer Name</b>	
<b>Customer Part Number</b>	

### Crystalfontz America, Incorporated

12412 East Saltese Avenue  
Spokane Valley, WA 99216-0357

Phone: (888) 206-9720

Fax: (509) 892-1203

Email: [techinfo@crystalfontz.com](mailto:techinfo@crystalfontz.com)

URL: [www.crystalfontz.com](http://www.crystalfontz.com)



## REVISION HISTORY

HARDWARE	
2005/08/01	Start Public Version Tracking. Current hardware version: <b>v2.0</b>

FIRMWARE	
2005/08/01	Start Public Version Tracking. Current firmware version: <b>v2.0</b> Command <a href="#">1: Get Hardware &amp; Firmware Version (Pg. 15)</a> returns: "CFA631:h2.0,v2.0"

DATA SHEET	
2005/08/01	Start Public Version Tracking. Data Sheet version: v2.0 Changes since last released version (v1.9): Added Revision History (this page). Added <a href="#">GPIO Current Limits (Pg. 8)</a> . Added <a href="#">APPENDIX C: CALCULATING THE CRC (Pg. 47)</a> . Added note on <a href="#">operating system delays (Pg. 13)</a> . Added note on <a href="#">length of command 30 reply (Pg. 30)</a> . Added documentation for commands requiring the CrystalFontz SCAB accessory. Corrected <a href="#">length returned by command 30 (Pg. 30)</a> .
2005/12/20	Current Data Sheet version: <b>v2.0a</b> Changes since last released version (v2.0): Corrected " <a href="#">Character Size</a> " and added " <a href="#">Character Pitch</a> " (Pg. 7). Corrected <a href="#">specification for supply voltage maximum (Pg. 8)</a> . Corrected return "type" for command <a href="#">26: Set Fan Tachometer Glitch Filter (SCAB required) (Pg. 26)</a> . Corrected return "type" for command <a href="#">27: Query Fan Power &amp; Fail-Safe Mask (SCAB required) (Pg. 27)</a> . Corrected "type" for command <a href="#">33: Set Baud Rate (Pg. 32)</a> . Corrected length returned by reply for command <a href="#">35: Read GPIO Pin Levels and Configuration State (Pg. 34)</a> . Formatting, content organization, and minor rewording to improve readability. For added convenience, a separate data sheet is available for each CFA-631 module variant.





# CONTENTS

<b>FEATURES</b>	<b>5</b>
<b>ORDERING INFORMATION</b>	<b>6</b>
<b>SYSTEM BLOCK DIAGRAM</b>	<b>6</b>
<b>PHYSICAL CHARACTERISTICS</b>	<b>7</b>
<b>TEMPERATURE RANGE</b>	<b>7</b>
<b>OPTICAL CHARACTERISTICS</b>	<b>7</b>
<b>ELECTRICAL SPECIFICATIONS</b>	<b>8</b>
<b>RELIABILITY</b>	<b>9</b>
<b>USB HOST CONNECTION</b>	<b>9</b>
<b>GPIO/GPO CONNECTIONS</b>	<b>10</b>
<b>SCAB CONNECTION</b>	<b>11</b>
<b>HOST COMMUNICATIONS</b>	<b>12</b>
<b>Packet Structure</b>	<b>12</b>
<b>About Handshaking</b>	<b>13</b>
<b>Report Codes</b>	<b>13</b>
0x80: Key Activity	13
0x81: Fan Speed Report (SCAB required)	13
0x82: Temperature Sensor Report (SCAB required)	14
<b>Command Codes</b>	<b>15</b>
0: Ping Command	15
1: Get Hardware & Firmware Version	15
2: Write User Flash Area	15
3: Read User Flash Area	16
4: Store Current State As Boot State	16
5: Reboot CFA-631, Reset Host (SCAB required), or Power Off Host (SCAB required)	17
6: Clear LCD Screen	17
7: Set LCD Contents, Line 1 (CFA-633 compatibility)	18
8: Set LCD Contents, Line 2 (CFA-633 compatibility)	18
9: Set LCD Special Character Data	18
10: Read 8 Bytes of LCD Memory	19
11: Set LCD Cursor Position	19
12: Set LCD Cursor Style	19
13: Set LCD Contrast	20
14: Set LCD & Keypad Backlight	20
16: Set Up Fan Reporting (SCAB required)	20
17: Set Fan Power (SCAB required)	21
18: Read DOW Device Information (SCAB required)	21
19: Set Up Temperature Reporting (SCAB required)	22
20: Arbitrary DOW Transaction (SCAB required)	23
21: Set Up Live Fan or Temperature Display (SCAB required)	24
22: Send Command Directly to the LCD Controller	25
23: Configure Key Reporting	25
24: Read Keypad, Polled Mode	25
25: Set Fan Power Fail-Safe (SCAB required)	26



## CONTENTS, CONTINUED

26: Set Fan Tachometer Glitch Filter (SCAB required)- .....	26
27: Query Fan Power & Fail-Safe Mask (SCAB required) .....	27
28: Set ATX Power Switch Functionality (SCAB required) .....	28
29: Enable/Disable and Reset the Watchdog (SCAB required)- .....	29
30: Read Reporting & Status- .....	30
31: Send Data to LCD .....	31
32: Key Legends .....	31
33: Set Baud Rate .....	32
34: Set or Set and Configure GPIO Pin .....	32
35: Read GPIO Pin Levels and Configuration State- .....	34
<b>CHARACTER GENERATOR ROM (CGROM) .....</b>	<b>36</b>
<b>CFA-631 MODULE OUTLINE DRAWING .....</b>	<b>37</b>
<b>JUMPER LOCATIONS AND FUNCTIONS .....</b>	<b>38</b>
<b>CARE AND HANDLING PRECAUTIONS .....</b>	<b>39</b>
<b>APPENDIX A:</b>	
<b>CONNECTING A DS2450 1-WIRE QUAD A/D CONVERTER (SCAB REQUIRED)- .....</b>	<b>41</b>
<b>APPENDIX B:</b>	
<b>CONNECTING A DS1963S SHA IButton (SCAB REQUIRED) .....</b>	<b>43</b>
<b>APPENDIX C:</b>	
<b>CALCULATING THE CRC .....</b>	<b>47</b>
<b>Algorithm 1: "C" Table Implementation .....</b>	<b>47</b>
<b>Algorithm 2: "C" Bit Shift Implementation .....</b>	<b>48</b>
<b>Algorithm 3: "PIC Assembly" Bit Shift Implementation .....</b>	<b>49</b>
<b>Algorithm 4: "Visual Basic" Table Implementation .....</b>	<b>51</b>
<b>Algorithm 5: "Java" Table Implementation .....</b>	<b>52</b>
<b>Algorithm 6: "Perl" Table Implementation .....</b>	<b>53</b>
<b>APPENDIX D:</b>	
<b>QUALITY ASSURANCE STANDARDS .....</b>	<b>55</b>

## LIST OF FIGURES

Figure 1. CFA631-RMF-KU System Block Diagram .....	6
Figure 2. CFA631-RMF-KU USB Host Connection .....	9
Figure 3. CFA631-RMF-KU has five GPIO connections on header "H1" .....	10
Figure 4. CFA-631 connected to a CrystalFontz SCAB using the WREXTY19 cable .....	11
Figure 5. Character Generator ROM (CGROM) .....	36
Figure 6. CFA-631 Module Outline Drawing (v2.0 identical to v1.0)- .....	37
Figure 7. CFA-631 Hardware v2.0 Jumper Locations and Functions .....	38
Appendix A Figure 1. CFA-631 Test Circuit Schematic .....	41
Appendix B Figure 1. Connect CFA-631 to Maxim/Dallas DS19632 SHA iButton using DS9094 iButton Clip 44	44



## FEATURES

---

- 20x2 LCD has compact size: 3½ inch floppy drive form factor and easily fits in 1U cases.
- USB interface (115200 baud equivalent throughput).
- Integrated LED backlit 4-button translucent silicon keypad.
- Red array LED backlit with STN-blue negative mode LCD (displays red characters on dark background).
- Red LED backlit keypad.
- Key legends allow assignment of keys to be shown easily on the LCD.
- LCD characters are contiguous in both X and Y directions to allow the host software to display “gapless” bar graphs in horizontal or vertical directions.
- Fully decoded keypad: any key combination is valid and unique.
- Robust packet-based communications protocol with 16-bit CRC.
- Built-in reprogrammable microcontroller (factory operation).
- Nonvolatile memory capability (EEPROM):
  - Customize the “power-on” display settings.
  - 16-byte “scratch” register for storing IP address, netmask, system serial number . . .
- Expandable firmware and configurable hardware can be customized to add specific features for your system needs (tooling fee and minimum order may apply).
  - Other additional analog or digital I/O devices.
  - Provide “dongle” functionality for software copy protection.
  - Autonomous hardware monitoring.
- Firmware support for the CrystalFontz accessory System Cooling Accessory Board (SCAB) For more information on the SCAB accessory see [CFA-SCAB](#) Data Sheet. The combination of the CFA631-RMF-KU with the SCAB (written as “CFA631-RMF-KU+SCAB” in this data sheet) allows:
  - ATX power supply control functionality allows the buttons on the CFA631-RMF-KU to replace the “power” and “reset” switches on your system, simplifying front panel design.
  - Four fan connectors with RPM monitoring and variable PWM fan power control.
  - Fail-safe fan power settings allows safe host fan control based on temperature.
  - Temperature monitoring: up to 32 channels at up to 0.5 degrees C absolute accuracy (using optional CrystalFontz [WRDOWY17](#) cable with Dallas 1-Wire sensor).
  - Hardware watchdog can reset host on host software failure.
  - “Live Display” shows up to four temperature or fan readings without host intervention, allowing fans and temperatures to be shown immediately at boot, even before the host operating system is loaded.
  - RS-232 to Dallas Semiconductor 1-Wire bridge functionality allows control of other 1-Wire compatible devices (ADC, voltage monitoring, current monitoring, RTC, GPIO, counters, identification/encryption). (Additional hardware required).



## ORDERING INFORMATION

PART NUMBER	FLUID	LCD GLASS COLOR	IMAGE	POLARIZER FILM	BACKLIGHTS
CFA631-RMF-KU	STN	blue	negative	transmissive	LCD: red array LEDs Keypad: red LEDs

## SYSTEM BLOCK DIAGRAM

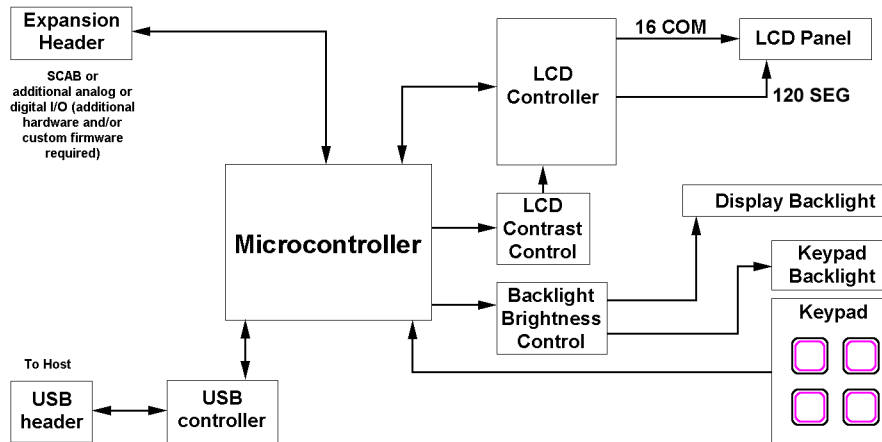

Figure 1. CFA631-RMF-KU System Block Diagram



## PHYSICAL CHARACTERISTICS

---

ITEM	SIZE (mm)
Module Dimensions	101.6 (W) x 25.4 (H)
Viewing Area	66.0 (W) x 13.8 (H)
Active Area	63.55 (W) x 10.35 (H)
Character Size	2.6 (W) x 4.5 (H)
Character Pitch	3.18 (W) x 5.2 (H)
Dot Size	0.48 (W) x 0.60 (H)
Dot Pitch	0.53 (W) x 0.65 (H)
Depth:	
Without Keypad or Overlay	90.0
Without Keypad, with Overlay	90.6
With Keypad	93.1
Keystroke Travel (approximate)	2
Weight	80 grams (typical)

## TEMPERATURE RANGE

---

CRITERIA	SPECIFICATION
Operating Temperature Range	0°C minimum to +50°C maximum
Storage Temperature Range	-10°C minimum to +60°C maximum

## OPTICAL CHARACTERISTICS

---

Viewing Direction	12 o'clock
-------------------	------------



## ELECTRICAL SPECIFICATIONS

DRIVING METHOD	SPECIFICATION
Duty	1/32
Bias	6.7

SUPPLY VOLTAGE	MINIMUM	NOMINAL	MAXIMUM
Supply voltage for driving the LCD module (normally supplied through USB connection)	+4.75v	+5.0v	+5.25v

TYPICAL CURRENT CONSUMPTION ( $V_{DD} = +5v$ )	BACKLIGHT ONLY	INCLUDING LOGIC
Logic + USB controller, backlight off	30 mA	
Logic + USB controller, backlight at 100%	150 mA	180mA

GPIO CURRENT LIMITS	SPECIFICATION
Sink	25 mA
Source	10 mA

ADDITIONAL CRITERIA	SPECIFICATION
Backlight PWM Frequency	320 Hz nominal
Fan Tachometer Speed Range* (assuming 2 PPR) <sup>†</sup>	600 RPM to 3,000,000 RPM
Fan Power Control PWM Frequency*	18 Hz nominal

\* When used with SCAB.

<sup>†</sup>PPR is "pulses per revolution", also written as "p/r".





### ESD (Electro-Static Discharge) Specifications:

D+ and D- pins of USB connector only: Electrostatic Discharge Voltage ( $I < 1 \mu A$ ): +/- 2000 V

The remainder of the circuitry is industry standard CMOS logic and susceptible to ESD damage. Please use industry standard antistatic precautions as you would for any other PCB such as expansion cards or motherboards. For more information, read [CARE AND HANDLING PRECAUTIONS \(Pg. 39\)](#).

## RELIABILITY

ITEM	SPECIFICATION
LCD portion (excluding Keypad and Backlights)	50,000 to 100,000 hours (typical)
Keypad	1,000,000 keystrokes
Red LED Backlights	50,000 to 100,000 hours (typical)

## USB HOST CONNECTION

The CFA631-RMF-KU is a USB peripheral, requiring only one connection to the host for both data communications and power supply.

The CFA631-RMF-KU uses a low profile 2 mm latching polarized connector for USB connection. CrystalFontz offers two cables that make the connection between the CFA631-RMF-KU and the host. The [WRUSBY03](#) has the mating 2mm connector on one end and a standard "USB A" on the other end. The [WRUSBY11](#) has the mating 2 mm connector on one end and standard single pin connectors on the opposite end. These single pin connectors are suitable to plug directly onto the USB headers typically found on motherboards.

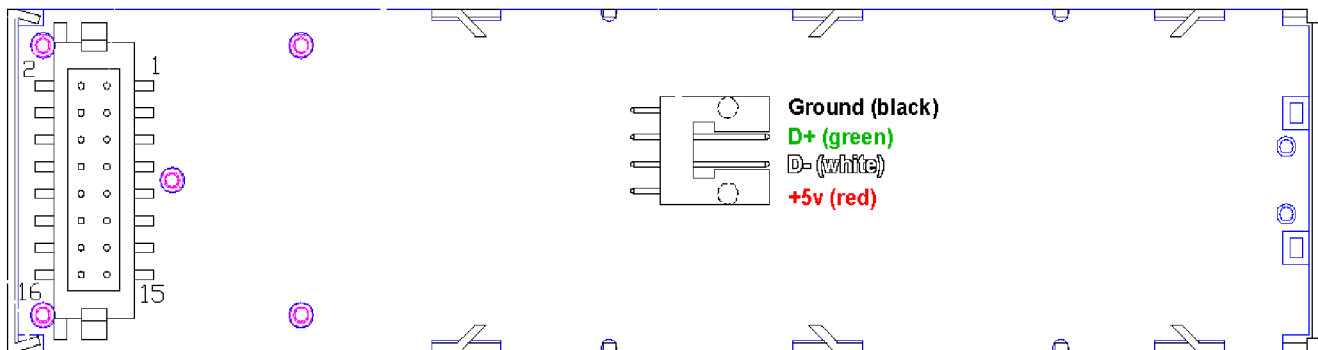

Figure 2. CFA631-RMF-KU USB Host Connection



If you would like to make your own cable, the connector on the CFA631-RMF-KU is:  
FCI/Berg 95000-004: SMT 2 mm connector, 4-position, polarized

The mating housing and terminals for the cable are:  
FCI/Berg 90312-004: Housing, 2 mm connector, 4-position, polarized  
FCI/Berg 77138-001: Terminal (4 pieces required)

## GPIO/GPO CONNECTIONS

CFA631-RMF-KU has 5 GPIOs available on header "H1". These GPIOs can be accessed directly through "H1" or through the CrystalFontz SCAB (System Cooling Accessory Board) connected to "H1". The SCAB can be easily connected to the CFA631-RMF-KU by using either the CrystalFontz [WREXTY15](#) or [WREXTY19](#) cables.

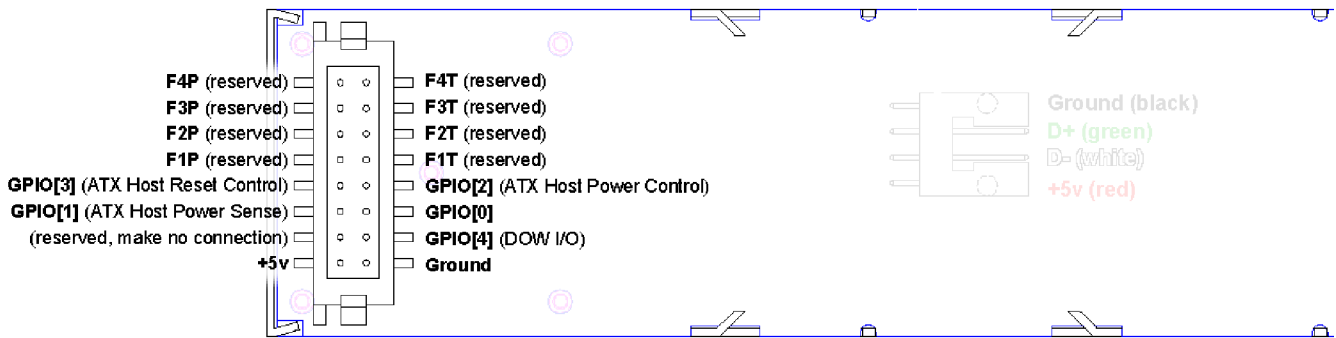

Figure 3. CFA631-RMF-KU has five GPIO connections on header "H1"

Please see the commands [34: Set or Set and Configure GPIO Pin \(Pg. 32\)](#), and [35: Read GPIO Pin Levels and Configuration State \(Pg. 34\)](#) below for details on how to control the GPIOs.

The following parts may be used to make a mating cable for H1:

- 16-position housing: Hirose DF11-16DS-2C / [Digi-Key H2025-ND](#)
- Terminal (tape & reel): Hirose DF11-2428SCF / [Digi-Key H1504TR-ND](#)
- Terminal (loose): Hirose DF11-2428SC / [Digi-Key H1504-ND](#)
- Pre-terminated interconnect wire: Hirose / [Digi-Key H3BBT-10112-B4-ND](#) is typical



## SCAB CONNECTION

---

The Crystalfontz SCAB is designed to connect to a CFA-631's "H1" header. The SCAB will receive the correct signals to operate from the CFA-631.

Here is a photo showing the CFA-631 connected to a SCAB using the [WREXTY19](#) cable:

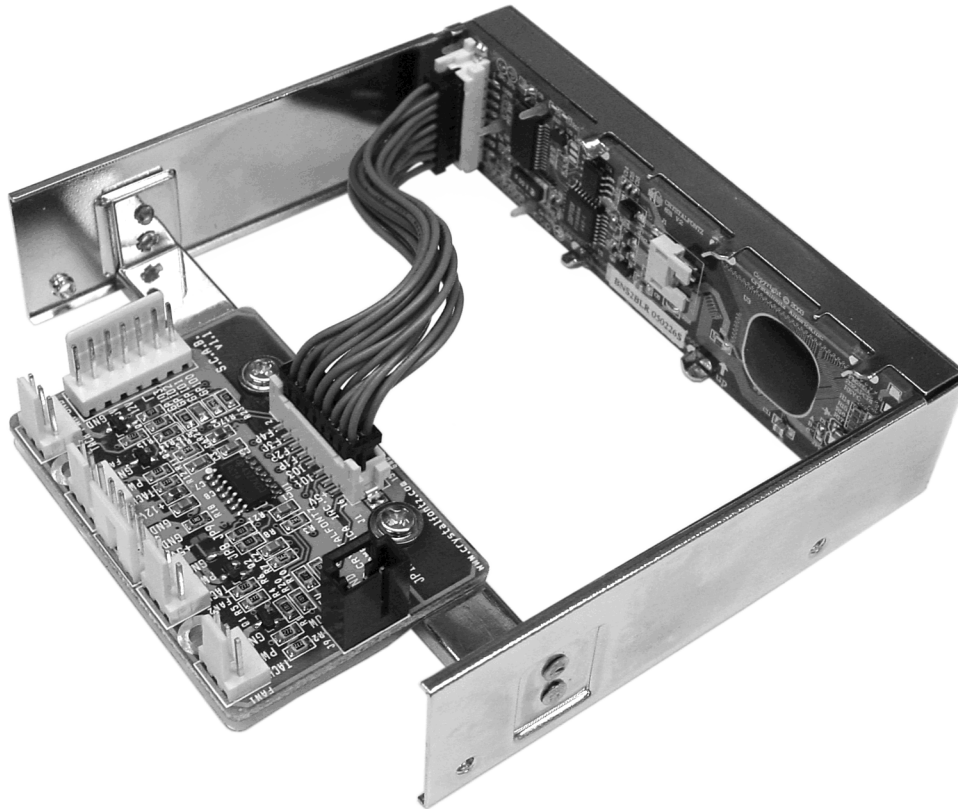

Figure 4. CFA-631 connected to a Crystalfontz SCAB using the WREXTY19 cable

There are two cables available from Crystalfontz to make the connection between the SCAB and the CFA-631:

- [WREXTY15](#): 18" SCAB connection cable
- [WREXTY19](#): 3.5" SCAB connection cable

The [WREXTY15](#) allows the SCAB to be mounted some distance away from the CFA-631. For instance, the SCAB could be mounted in a central location within the PC's case. The WREXTY15 would connect from this central location to the LCD module that is mounted in a drive bay. Then the connections to the fans and temperature sensors would only need to be run to the SCAB, not all the way to the front panel where the LCD module is mounted.

The [WREXTY19](#) is intended to be used when the SCAB is mounted in close proximity to the CFA-631 as is the case when the SCAB is fastened directly to the LCD module's mounting bracket.





automatically re-synchronize to the next valid packet in the event of any communications errors. Please follow the algorithm in the sample code closely in order to realize the benefits of using the packet communications.

## ABOUT HANDSHAKING

The nature of CFA-631's packets makes it unnecessary to implement traditional hardware or software handshaking.

The host should wait for a corresponding acknowledge packet from the CFA-631 before sending the next command packet. The CFA-631 will respond to all packets within 250 mS. The host software should stop waiting and retry the packet if the CFA-631 fails to respond within 250 mS. The host software should report an error if a packet is not acknowledged after several retries. This situation indicates a hardware problem—for example, a disconnected cable. Please note that some operating systems may introduce delays between when the data arrives at the physical port from the CFA-631 until it is available to the user program. In this case, the host program may have to increase its timeout window to account for the additional overhead of the operating system.

The CFA-631 can be configured to send several types of report packets along with regular acknowledge packets. The host should be able to buffer several incoming packets and must guarantee that it can process and remove packets from its input buffer faster than the packets can arrive given the 115200 equivalent baud rate of the VCP and the reporting configuration of the CFA-631. For any modern PC using reasonably efficient software, this requirement will not pose a challenge.

The report packets are sent asynchronously with respect to the command packets received from the host. The host should not assume that the first packet received after it sends a command is the acknowledge packet for that command. The host should inspect the `type` field of incoming packets and process them accordingly.

## REPORT CODES

The CFA-631 can be configured to report three items. The CFA-631 sends reports automatically when the data becomes available. Reports are not sent in response to a particular packet received from the host. The three report types are:

### 0x80: Key Activity

If a key is pressed or released, the CFA-631 sends a Key Activity report packet to the host. Key event reporting may be individually enabled or disabled by command [23: Configure Key Reporting \(Pg. 25\)](#).

```
type = 0x80
data_length = 1
data[0] is the type of keyboard activity:
KEY_UL_PRESS    13
KEY_UR_PRESS    14
KEY_LL_PRESS    15
KEY_LR_PRESS    16
KEY_UL_RELEASE  17
KEY_UR_RELEASE  18
KEY_LL_RELEASE  19
KEY_LR_RELEASE  20
```

Please note that the [CFA-633](#) and [CFA-635](#) will return codes 1 through 12. Please see those data sheets on our website for more details.

### 0x81: Fan Speed Report (SCAB required)

If any of up to four fans connected to CFA-631+SCAB is configured to report its speed information to the host, the CFA-631 will send Fan Speed Reports for each selected fan every 1/2 second. See command [16: Set Up Fan Reporting \(SCAB required\) \(Pg. 20\)](#) below.



```
type = 0x81
data_length = 4
data[0] is the index of the fan being reported:
    0 = FAN 1
    1 = FAN 2
    2 = FAN 3
    3 = FAN 4
data[1] is number of fan tach cycles
data[2] is the MSB of Fan_Timer_Ticks
data[3] is the LSB of Fan_Timer_Ticks
```

The following C function will decode the fan speed from a Fan Speed Report packet into RPM:

```
int OnReceivedFanReport(COMMAND_PACKET *packet, char * output)
{
    int
    return_value;
    return_value=0;

    int
    number_of_fan_tach_cycles;
    number_of_fan_tach_cycles=packet->data[1];

    if(number_of_fan_tach_cycles<3)
        sprintf(output," STOP");
    else if(number_of_fan_tach_cycles<4)
        sprintf(output," SLOW");
    else if(0xFF==number_of_fan_tach_cycles)
        sprintf(output," ----");
    else
    {
        //Specific to each fan, most commonly 2
        int
        pulses_per_revolution;
        pulses_per_revolution=2;

        int
        Fan_Timer_Ticks;
        Fan_Timer_Ticks=(*(unsigned short *)(&(packet->data[2])));

        return_value=((27692308L/pulses_per_revolution)*
            (unsigned long)(number_of_fan_tach_cycles-3))/
            (Fan_Timer_Ticks);
        sprintf(output,"%5d",return_value);
    }
    return(return_value);
}
```

## 0x82: Temperature Sensor Report (SCAB required)

If any of the up to 32 temperature sensors is configured to report to the host, the CFA-631+SCAB will send Temperature Sensor Reports for each selected sensor every second. See the command [19: Set Up Temperature Reporting \(SCAB required\) \(Pg. 22\)](#) below.

```
type = 0x82
data_length = 4
data[0] is the index of the temperature sensor being reported:
    0 = temperature sensor 1
    1 = temperature sensor 2
    .
    .
    31 = temperature sensor 32
data[1] is the LSB of Temperature_Sensor_Counts
data[2] is the MSB of Temperature_Sensor_Counts
data[3] is DOW_crc_status
```



The following C function will decode the Temperature Sensor Report packet into °C and °F:

```
void OnReceivedTempReport(COMMAND_PACKET *packet, char *output)
{
    //First check the DOW CRC return code from the CFA-631
    if(packet->data[3]==0)
        strcpy(output, "BAD CRC");
    else
    {
        double
            degc;
        degc=(*(short *)&(packet->data[1]))/16.0;

        double
            degf;
        degf=(degc*9.0)/5.0+32.0;

        sprintf(output, "%9.4f°C =%9.4f°F",
                degc,
                degf);
    }
}
```

## COMMAND CODES

Below is a list of valid commands for the CFA-631. Each command packet is answered by either a response packet or an error packet. The low 6 bits of the type field of the response or error packet is the same as the low 6 bits of the type field of the command packet being acknowledged.

### 0: Ping Command

The CFA-631 will return the Ping Command to the host.

```
type = 0
valid data_length is 0 to 16
data[0-(data_length-1)] can be filled with any arbitrary data
```

The return packet is identical to the packet sent, except the type will be 0x40 (normal response, Ping Command):

```
type = 0x40 | 0
data_length = (identical to received packet)
data[0-(data_length-1)] = (identical to received packet)
```

### 1: Get Hardware & Firmware Version

The CFA-631 will return the hardware and firmware version information to the host.

```
type = 1
valid data_length is 0
```

The return packet will be:

```
type = 0x40 | 1
data_length = 16
data[] = "CFA631:hX.X,yY.Y"
```

X.X is the hardware revision, "2.0" for example  
yY.Y is the firmware version, "v2.0" for example

### 2: Write User Flash Area

The CFA-631 reserves 16 bytes of nonvolatile memory for arbitrary use by the host. This memory can be used to store a serial number, IP address, gateway address, netmask, or any other data required. All 16 bytes must be supplied.



```
type = 2
valid data_length is 16
data[] = 16 bytes of arbitrary user data to be stored in
        the CFA-631's non-volatile memory
```

The return packet will be:

```
type = 0x40 | 2
data_length = 0
```

### 3: Read User Flash Area

This command will read the User Flash Area and return the data to the host.

```
type = 3
valid data_length is 0
```

The return packet will be:

```
type = 0x40 | 3
data_length = 16
data[] = 16 bytes user data recalled from the CFA-631's
        non-volatile memory
```

### 4: Store Current State As Boot State

The CFA-631 loads its power-up configuration from nonvolatile memory when power is applied. The CFA-631 is configured at the factory to display a “welcome screen” when power is applied. This command can be used to customize the welcome screen, as well as the following items:

- Characters shown on LCD, which are affected by:
  - command [6: Clear LCD Screen \(Pg. 17\)](#)
  - command [7: Set LCD Contents, Line 1 \(CFA-633 compatibility\) \(Pg. 18\)](#)
  - command [8: Set LCD Contents, Line 2 \(CFA-633 compatibility\) \(Pg. 18\)](#)
  - command [31: Send Data to LCD \(Pg. 31\)](#)
- Special character font definitions (command [9: Set LCD Special Character Data \(Pg. 18\)](#))
- Cursor position (command [11: Set LCD Cursor Position \(Pg. 19\)](#))
- Cursor style (command [12: Set LCD Cursor Style \(Pg. 19\)](#))
- Contrast setting (command [13: Set LCD Contrast \(Pg. 20\)](#))
- Backlight setting (command [14: Set LCD & Keypad Backlight \(Pg. 20\)](#))
- Fan power settings (command [17: Set Fan Power \(SCAB required\) \(Pg. 21\)](#))
- Settings of any “live” displays (command [21: Set Up Live Fan or Temperature Display \(SCAB required\) \(Pg. 24\)](#))
- Key press and release masks (command [23: Configure Key Reporting \(Pg. 25\)](#))
- Fan glitch delay settings (command [26: Set Fan Tachometer Glitch Filter \(SCAB required\) \(Pg. 26\)](#))
- ATX function enable and pulse length settings (command [28: Set ATX Power Switch Functionality \(SCAB required\) \(Pg. 28\)](#))
- Key legends (command [32: Key Legends \(Pg. 31\)](#))
- Baud rate (command [33: Set Baud Rate \(Pg. 32\)](#))
- GPIO settings (command [34: Set or Set and Configure GPIO Pin \(Pg. 32\)](#))

You cannot store the fan or temperature reporting (although the live display of fans or temperatures can be saved). You cannot store the fan fail-safe or host watchdog. The host software should enable these items once the system is initialized and it is ready to receive the data.

```
type = 4
valid data_length is 0
```





The return packet will be:

```
type = 0x40 | 4  
data_length = 0
```

## 5: Reboot CFA-631, Reset Host (SCAB required), or Power Off Host (SCAB required)

This command instructs the CFA-631+SCAB to simulate a power-on restart of itself, reset the host, or turn the host's power off. The ability to reset the host may be useful to allow certain host operating system configuration changes to complete. The ability to turn the host's power off under software control may be useful in systems that do not have ACPI compatible BIOS.

### NOTE

The GPIO pins used for ATX control must not be configured as user GPIO, and must be configured to their default drive mode in order for the ATX functions to work correctly. These settings are factory default, but may be changed by the user. Please see command [34: Set or Set and Configure GPIO Pin \(Pg. 32\)](#).

Rebooting the CFA-631 may be useful when testing the boot configuration. It may also be useful to re-enumerate the devices on the 1-Wire bus (SCAB required). To reboot the CFA-631, send the following packet:

```
type = 5  
valid data_length is 3  
data[0] = 8  
data[1] = 18  
data[2] = 99
```

To reset the host (SCAB required), assuming the host's reset line is connected to GPIO[3] as described in command [28: Set ATX Power Switch Functionality \(SCAB required\) \(Pg. 28\)](#), send the following packet:

```
type = 5  
valid data_length is 3  
data[0] = 12  
data[1] = 28  
data[2] = 97
```

To turn the host's power off (SCAB required), assuming the host's power control line is connected to GPIO[2] as described in command [28: Set ATX Power Switch Functionality \(SCAB required\) \(Pg. 28\)](#), send the following packet:

```
type = 5  
valid data_length is 3  
data[0] = 3  
data[1] = 11  
data[2] = 95
```

In any of the above cases, the return packet will be:

```
type = 0x40 | 5  
data_length = 0
```

## 6: Clear LCD Screen

Sets the contents of the LCD screen DDRAM to ' ' = 0x20 = 32 and moves the cursor to the left-most column of the top line.

```
type = 6  
valid data_length is 0
```

The return packet will be:

```
type = 0x40 | 6  
data_length = 0
```



Clear LCD Screen is one of the items stored by the command [4: Store Current State As Boot State \(Pg. 16\)](#).

## 7: Set LCD Contents, Line 1 (CFA-633 compatibility)

Sets the center 16 characters displayed for the top line of LCD screen. The first two and last two characters are blanked.

This command is provided to allow legacy software that displays data on the CFA-633 to work unchanged on the CFA-631. For new applications, please use the more flexible command [31: Send Data to LCD \(Pg. 31\)](#).

```
type = 7
valid data_length is 16
data[] = top line's display content (must supply 16 bytes)
```

The return packet will be:

```
type = 0x40 | 7
data_length = 0
```

Set LCD Contents, Line 1 is one of the items stored by the command [4: Store Current State As Boot State \(Pg. 16\)](#).

## 8: Set LCD Contents, Line 2 (CFA-633 compatibility)

Sets the center 16 characters displayed for the bottom line of LCD screen. The first two and last two characters are blanked.

This command is provided to allow legacy software that displays data on the CFA-633 to work unchanged on the CFA-631. For new applications, please use the more flexible command [31: Send Data to LCD \(Pg. 31\)](#).

```
type = 8
valid data_length is 16
data[] = top line's display content (must supply 16 bytes)
```

The return packet will be:

```
type = 0x40 | 8
data_length = 0
```

Set LCD Contents, Line 2 is one of the items stored by the command [4: Store Current State As Boot State \(Pg. 16\)](#).

## 9: Set LCD Special Character Data

Sets the font definition for one of the special characters (CGRAM).

```
type = 9
valid data_length is 9
data[0] = index of special character that you would like
          to modify, 0-7 are valid
data[1-8] = bitmap of the new font for this character
```

`data[1-8]` are the bitmap information for this character. Any value is valid between 0 and 63, the msb is at the left of the character cell of the row, and the lsb is at the right of the character cell. `data[1]` is at the top of the cell, `data[8]` is at the bottom of the cell.

Additionally, if you set bit 7 of any of the data bytes, the entire line will blink.

The return packet will be:

```
type = 0x40 | 9
data_length = 0
```



Set LCD Special Character Data is one of the items stored by the command [4: Store Current State As Boot State \(Pg. 16\)](#).

## 10: Read 8 Bytes of LCD Memory

This command will return the contents of the LCD's DDRAM or CGRAM. This command is intended for debugging.

```
type = 10
valid data_length is 1
data[0] = address code of desired data
```

data [0] is the address code native to the LCD controller:

```
0x40 (\064) to 0x7F (\127) for CGRAM
0x80 (\128) to 0x93 (\147) for DDRAM, line 1
0xC0 (\192) to 0xD3 (\211) for DDRAM, line 2
```

The return packet will be:

```
type = 0x40 | 10
data_length = 9
```

data [0] of the return packet will be the address code.

data [1-8] of the return packet will be the data read from the LCD controller's memory.

## 11: Set LCD Cursor Position

This command allows the cursor to be placed at the desired location on the CFA-631's LCD screen. If you want the cursor to be visible, you may also need to send a command [12: Set LCD Cursor Style \(Pg. 19\)](#).

```
type = 11
valid data_length is 2
data[0] = column (0-19 valid)
data[1] = row (0-1 valid)
```

The return packet will be:

```
type = 0x40 | 11
data_length = 0
```

Set LCD Cursor Position is one of the items stored by the command [4: Store Current State As Boot State \(Pg. 16\)](#).

## 12: Set LCD Cursor Style

This command allows you to select among four hardware generated cursor options.

```
type = 12
valid data_length is 1
data[0] = cursor style (0-4 valid)
0 = no cursor
1 = blinking block cursor
2 = underscore cursor
3 = blinking block plus underscore
4 = inverting, blinking block
```

The return packet will be:

```
type = 0x40 | 12
data_length = 0
```

Set LCD Cursor Style is one of the items stored by the command [4: Store Current State As Boot State \(Pg. 16\)](#).





Reporting a fan will override the fan power setting to 100% for up to 1/8 of a second every 1/2 second. Please see Fan Connections in [CFA-SCAB Data Sheet](#) for a detailed description.

## 17: Set Fan Power (SCAB required)

This command will configure the power for the fan connectors. The fan power setting is one of the items stored by the command [4: Store Current State As Boot State \(Pg. 16\)](#).

```
type = 17
valid data_length is 4
data[0] = power level for FAN 1 (0-100 valid)
data[1] = power level for FAN 2 (0-100 valid)
data[2] = power level for FAN 3 (0-100 valid)
data[3] = power level for FAN 4 (0-100 valid)
```

The return packet will be:

```
type = 0x40 | 17
data_length = 0
```

Set Fan Power is one of the items stored by the command [4: Store Current State As Boot State \(Pg. 16\)](#).

## 18: Read DOW Device Information (SCAB required)

When power is applied to the CFA-631+SCAB, it detects any devices connected to the Dallas Semiconductor 1-Wire (DOW) bus and stores the device's information. This command will allow the host to read the device's information.

The first byte returned is the Family Code of the Dallas 1-Wire / iButton device. There is a list of the possible Dallas 1-Wire / iButton device family codes available in [App Note 155: 1-Wire Software Resource Guide](#) on the Maxim/Dallas website..

### **NOTE ON COMMAND 18: READ DOW DEVICE INFORMATION**

The GPIO pin used for DOW must not be configured as user GPIO. It must be configured to its default drive mode in order for the DOW functions to work correctly.

These settings are factory default but may be changed by the user. Please see command [34: Set or Set and Configure GPIO Pin \(Pg. 32\)](#).

In order for the DOW subsystem to be enabled and operate correctly, user GPIO[4] must be configured as:

```
DDD = "111: 1=Hi-Z, 0=Slow, Strong Drive Down".
F = "0: Port unused for user GPIO."
```

This state is the factory default, but it can be changed and saved by the user. To ensure that GPIO[4] is set correctly and the DOW operation is enabled, send the following command:

```
command = 34
length = 3
data[0] = 4
data[1] = 100
data[2] = 7
```

This setting must be saved as the boot state, so when the CFA-631+SCAB reboots it will detect the DOW devices.

```
type = 18
valid data_length is 1
data[0] = device index (0-31 valid)
```



The return packet will be:

```
type = 0x40 | 18
data_length = 9
data[0] = device index (0-31 valid)
data[1-8] = ROM ID of the device
```

If data[1] is 0x22 ([DS1822](#) Econo 1-Wire Digital Thermometer temperature sensor) or 0x28 ([DS18B20](#) High Precision 1-Wire Digital Thermometer temperature sensor), then that device can be set up to automatically convert and report the temperature every second. See the command [19: Set Up Temperature Reporting \(SCAB required\) \(Pg. 22\)](#).

## 19: Set Up Temperature Reporting (SCAB required)

This command will configure the CFA-631 to report the temperature information to the host every second.

```
type = 19
valid data_length is 4
data[0-3] = 32-bit bitmask indicating which temperature
            sensors fans are enabled to report (0-255
            valid in each location)
```

```
data[0]
08 07 06 05 04 03 02 01 Enable Reporting of sensor with
| | | | | | | | device index of:
| | | | | | | | -- 0: 1 = enable, 0 = disable
| | | | | | | | ---- 1: 1 = enable, 0 = disable
| | | | | | | | ----- 2: 1 = enable, 0 = disable
| | | | | | | | ----- 3: 1 = enable, 0 = disable
| | | | | | | | ----- 4: 1 = enable, 0 = disable
| | | | | | | | ----- 5: 1 = enable, 0 = disable
| | | | | | | | ----- 6: 1 = enable, 0 = disable
| | | | | | | | ----- 7: 1 = enable, 0 = disable
```

```
data[1]
16 15 14 13 12 11 10 09 Enable Reporting of sensor with
| | | | | | | | device index of:
| | | | | | | | -- 8: 1 = enable, 0 = disable
| | | | | | | | ---- 9: 1 = enable, 0 = disable
| | | | | | | | ----- 10: 1 = enable, 0 = disable
| | | | | | | | ----- 11: 1 = enable, 0 = disable
| | | | | | | | ----- 12: 1 = enable, 0 = disable
| | | | | | | | ----- 13: 1 = enable, 0 = disable
| | | | | | | | ----- 14: 1 = enable, 0 = disable
| | | | | | | | ----- 15: 1 = enable, 0 = disable
```

```
data[2]
24 23 22 21 20 19 18 17 Enable Reporting of sensor with
| | | | | | | | device index of:
| | | | | | | | -- 16: 1 = enable, 0 = disable
| | | | | | | | ---- 17: 1 = enable, 0 = disable
| | | | | | | | ----- 18: 1 = enable, 0 = disable
| | | | | | | | ----- 19: 1 = enable, 0 = disable
| | | | | | | | ----- 20: 1 = enable, 0 = disable
| | | | | | | | ----- 21: 1 = enable, 0 = disable
| | | | | | | | ----- 22: 1 = enable, 0 = disable
| | | | | | | | ----- 23: 1 = enable, 0 = disable
```

(Continues on the next page.)

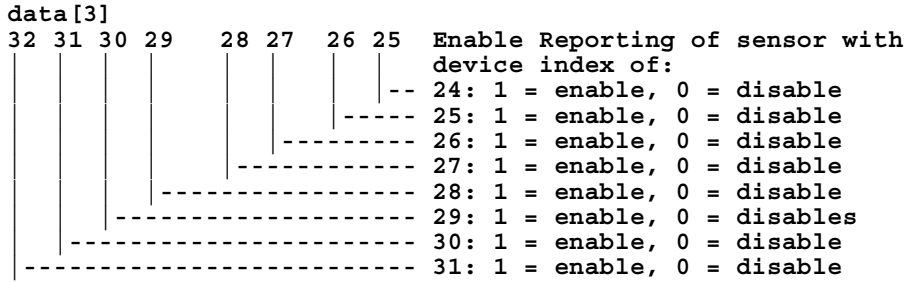

Any sensor enabled must have been detected as a 0x22 (DS1822 temperature sensor) or 0x28 (DS18B20 temperature sensor) during DOW enumeration. This can be verified by using the command [18: Read DOW Device Information \(SCAB required\) \(Pg. 21\)](#).

The return packet will be:

```

type = 0x40 | 19
data_length = 0

```

## 20: Arbitrary DOW Transaction (SCAB required)

The CFA-631+SCAB can function as a RS-232 to Dallas 1-Wire bridge. This command allows you to specify arbitrary transactions on the 1-Wire bus. 1-Wire commands follow this basic layout:

```

<bus reset          //Required
<address_phase>    //Must be "Match ROM" or "Skip ROM"
<write_phase>      //optional, but at least one of write_phase or read_phase must be sent
<read_phase>       //optional, but at least one of write_phase or read_phase must be sent

```

Please see [APPENDIX A: CONNECTING A DS2450 1-WIRE QUAD A/D CONVERTER \(SCAB REQUIRED\) \(Pg. 41\)](#) for an example of using this command.

```

type = 20
valid data_length is 2 to 16
data[0] = device_index (0-32 valid)
data[1] = number_of_bytes_to_read (0-14 valid)
data[2-15] = data_to_be_written[data_length-2]

```

If `device_index` is 32, then no address phase will be executed. If `device_index` is in the range of 0 to 31, and a 1-Wire device was detected for that `device_index` at power on, then the write cycle will be prefixed with a "Match ROM" command and the address information for that device.

If `data_length` is two, then no specific write phase will be executed (although address information may be written independently of `data_length` depending on the value of `device_index`).

If `data_length` is greater than two, then `data_length-2` bytes of `data_to_be_written` will be written to the 1-Wire bus immediately after the address phase.

If `number_of_bytes_to_read` is zero, then no read phase will be executed. If `number_of_bytes_to_read` is not zero then `number_of_bytes_to_read` will be read from the bus and loaded into the response packet.

The return packet will be:

```

type = 0x40 | 20
data_length = 2 to 16
data[0] = device_index (0-31 valid)
data[data_length-2] = Data read from the 1-Wire bus. This is the same
                    as number_of_bytes_to_read from the command.
data[data_length-1] = 1-Wire CRC

```



## 21: Set Up Live Fan or Temperature Display (SCAB required)

You can configure the CFA-631+SCAB to automatically update a portion of the LCD with a "live" RPM or temperature reading. Once the display is configured using this command, the CFA-631+SCAB will continue to display the live reading on the LCD without host intervention. The Set Up Live Fan or Temperature Display is one of the items stored by command [4: Store Current State As Boot State \(Pg. 16\)](#), so you can configure the CFA-631+SCAB to immediately display fan speeds or system temperatures as soon as power is applied.

The live display is based on a concept of display slots. There are 4 slots, and each of the 4 slots may be enabled or disabled independently.

Any slot may be requested to display any data that is available. For instance, slot 0 could display temperature sensor 3 in °C, while slot 1 could simultaneously display temperature sensor 3 in °F.

Any slot may be positioned at any location on the LCD, as long as all the digits of that slot fall fully within the display area. It is legal to have the display area of one slot overlap the display area of another slot, but senseless. This situation should be avoided in order to have meaningful information displayed.

```
type = 21
valid data_length is 7 or 2 (for turning a slot off)
data[0]: display slot (0-3)
data[1]: type of item to display in this slot
         0 = nothing (data_length then must be 2)
         1 = fan tachometer RPM (data_length then must be 7)
         2 = temperature (data_length then must be 7)
data[2]: index of the sensor to display in this slot:
         0-3 are valid for fans
         0-31 are valid for temperatures (and the temperature
         device must be attached)
data[3]: number of digits
         for a fan: 4 digits (0 to 9999) valid fan speed range
         for a fan: 5 digits (0 to 50000) valid fan speed range
         for a temperature: 3 digits ( -XX or XXX)
         for a temperature: 5 digits (-XX.X or XXX.X)
data[4]: display column
         0-13 valid for a 3-digit temperature
         0-12 valid for a 4-digit fan
         0-11 valid for a 5-digit fan or temperature
data[5]: display row (0-1 valid)
data[6]: pulses_per_revolution or temperature units
         for a fan: pulses per revolution for this fan (1 to 32)
         for a temperature: units (0 = deg C, 1 = deg F)
```

If a 1-Wire CRC error is detected, the temperature will be displayed as "ERR" or "ERROR".

If the frequency of the tachometer signal is below the detectable range, the speed will be displayed as "SLOW" or "STOP".

Displaying a fan will override the fan power setting to 100% for up to 1/8 of a second every 1/2 second. Please see Fan Connections in [CFA-SCAB](#) Data Sheet for a detailed description.

The return packet will be:

```
type = 0x40 | 21
data_length = 0
```





## 22: Send Command Directly to the LCD Controller

The LCD controller on the CFA-631 is S6A0073 compatible. Generally you won't need low-level access to the LCD controller but some arcane functions of the S6A0073 are not exposed by the CFA-631's command set. This command allows you to access the CFA-631's LCD controller directly. Note: It is possible to corrupt the CFA-631 display using this command.

```
type = 22
data_length = 2
data[0]: location code
    0 = "Data" register
    1 = "Control" register, RE=0
    2 = "Control" register, RE=1
data[1]: data to write to the selected register
```

The return packet will be:

```
type = 0x40 | 22
data_length = 0
```

## 23: Configure Key Reporting

By default, the CFA-631 reports any key event to the host. This command allows the key events to be enabled or disabled on an individual basis. The key events set to report are one of the items stored by the command [4: Store Current State As Boot State \(Pg. 16\)](#).

```
#define KP_UL    0x01 //(upper-left)
#define KP_UR    0x02 //(upper-right)
#define KP_LL    0x04 //(lower-left)
#define KP_LR    0x08 //(lower-right)

type = 23
data_length = 2
data[0]: press mask
data[1]: release mask
```

The return packet will be:

```
type = 0x40 | 23
data_length = 0
```

Configure Key Reporting is one of the items stored by the command [4: Store Current State As Boot State \(Pg. 16\)](#).

## 24: Read Keypad, Polled Mode

In some situations, it may be convenient for the host to poll the CFA-631 for key activity. This command allows the host to detect which keys are currently pressed, which keys have been pressed since the last poll, and which keys have been released since the last poll.

This command is independent of the key reporting masks set by command [23: Configure Key Reporting \(Pg. 25\)](#). All keys are always visible to this command. Typically both masks of command 23 would be set to "0" if the host is reading the keypad in polled mode.

```
#define KP_UL    0x01 //(upper-left)
#define KP_UR    0x02 //(upper-right)
#define KP_LL    0x04 //(lower-left)
#define KP_LR    0x08 //(lower-right)

type = 24
data_length = 0
```



The return packet will be:

```
type = 0x40 | 24
data_length = 3
data[0] = bit mask showing the keys currently pressed
data[1] = bit mask showing the keys that have been pressed since
          the last poll
data[2] = bit mask showing the keys that have been released since
          the last poll
```

## 25: Set Fan Power Fail-Safe (SCAB required)

The combination of the CFA-631+SCAB can be used as part of an active cooling system. For instance, the fans in a system can be slowed down to reduce noise when a system is idle or when the ambient temperature is low, and sped up when the system is under heavy load or the ambient temperature is high.

Since there are a very large number of ways to control the speed of the fans (thresholds, thermostat, proportional, PID, multiple temperature sensors “contributing” to the speed of several fans . . .) there was no way to foresee the particular requirements of your system and include an algorithm in the CFA-631’s firmware that would be an optimal fit for your application.

Varying fan speeds under host software control gives the ultimate flexibility in system design but would typically have a fatal flaw: a host software or hardware failure could cause the cooling system to fail. If the fans were set at a slow speed when the host software failed, system components may be damaged due to inadequate cooling.

The fan power fail-safe command allows host control of the fans without compromising safety. When the fan control software activates, it should set the fans that are under its control to fail-safe mode with an appropriate timeout value. If for any reason the host fails to update the power of the fans before the timeout expires, the fans previously set to fail-safe mode will be forced to 100% power.

```
#define FAN_1      0x01
#define FAN_2      0x02
#define FAN_3      0x04
#define FAN_4      0x08

type = 25
data_length = 2
data[0] = bit mask of fans set to fail-safe
data[1] = timeout value in 1/8 second ticks:
          1 = 1/8 second
          2 = 1/4 second
          255 = 31 7/8 seconds
```

The return packet will be:

```
type = 0x40 | 25
data_length = 0
```

## 26: Set Fan Tachometer Glitch Filter (SCAB required)

The combination of the CFA-631+SCAB controls fan speed by using PWM. Using PWM turns the power to a fan on and off quickly to change the average power delivered to the fan. The CFA-631 uses approximately 18 Hz for the PWM repetition rate. The fan’s tachometer output is only valid if power is applied to the fan. Most fans produce a valid tachometer output very quickly after the fan has been turned back on but some fans take time after being turned on before their tachometer output is valid.

This command allows you to set a variable-length delay after the fan has been turned on before the CFA-631 will recognize transitions on the tachometer line. The delay is specified in counts, each count being nominally 552.5 μS long (1/100 of one period of the 18 Hz PWM repetition rate).



In practice, most fans will not need the delay to be changed from the default length of 1 count. If a fan's tachometer output is not stable when its PWM setting is other than 100%, simply increase the delay until the reading is stable. Typically you would (1) start at a delay count of 50 or 100, (2) reduce it until the problem reappears, and then (3) slightly increase the delay count to give it some margin.

Setting the glitch delay to higher values will make the RPM monitoring slightly more intrusive at low power settings. Also, the higher values will increase the lowest speed that a fan with RPM reporting enabled will "seek" at "0%" power setting.

The Fan Glitch Delay is one of the items stored by the command [4: Store Current State As Boot State \(Pg. 16\)](#).

```
type = 26
data_length = 4
data[0] = delay count of fan 1
data[1] = delay count of fan 2
data[2] = delay count of fan 3
data[3] = delay count of fan 4
```

The return packet will be:

```
type = 0x40 | 26
data_length = 0
```

## 27: Query Fan Power & Fail-Safe Mask (SCAB required)

This command can be used to verify the current fan power and verify which fans are set to fail-safe mode.

```
#define FAN_1      0x01
#define FAN_2      0x02
#define FAN_3      0x04
#define FAN_4      0x08

type = 27
data_length = 0
```

The return packet will be:

```
type = 0x40 | 27
data_length = 5
data[0] = fan 1 power
data[1] = fan 2 power
data[2] = fan 3 power
data[3] = fan 4 power
data[4] = bit mask of fans with fail-safe set
```



## 28: Set ATX Power Switch Functionality (SCAB required)

The combination of the CFA-631+SCAB with the optional [WRPWRY14](#) cable can be used to replace the function of the power and reset switches in a standard ATX-compatible system. The ATX Power Switch Functionality is one of the items stored by the command [4: Store Current State As Boot State \(Pg. 16\)](#)

### **NOTE ON COMMAND 28: SET ATX POWER SWITCH FUNCTIONALITY**

The GPIO pins used for ATX control must not be configured as user GPIO. The pins must be configured to their default drive mode in order for the ATX functions to work correctly.

These settings are factory default but may be changed by the user. Please see command [34: Set or Set and Configure GPIO Pin \(Pg. 32\)](#). These settings must be saved as the boot state.

To ensure that GPIO[1] will operate correctly as ATX SENSE, user GPIO[1] must be configured as:

```
DDD = "011: 1=Resistive Pull Up, 0=Fast, Strong Drive Down".  
F = "0: Port unused for user GPIO."
```

This configuration can be assured by sending the following command:

```
command = 34  
length = 3  
data[0] = 1  
data[1] = 0  
data[2] = 3
```

To ensure that GPIO[2] will operate correctly as ATX POWER, user GPIO[2] must be configured as:

```
DDD = "010: Hi-Z, use for input".  
F = "0: Port unused for user GPIO."
```

This configuration can be assured by sending the following command:

```
command = 34  
length = 3  
data[0] = 2  
data[1] = 0  
data[2] = 2
```

To ensure that GPIO[3] will operate correctly as ATX RESET, user GPIO[3] must be configured as:

```
DDD = "010: Hi-Z, use for input".  
F = "0: Port unused for user GPIO."
```

This configuration can be assured by sending the following command:

```
command = 34  
length = 3  
data[0] = 3  
data[1] = 0  
data[2] = 2
```

These settings must be saved as the boot state.

The RESET (GPIO[3]) and POWER CONTROL (GPIO[2]) lines on the CFA-631+SCAB are normally high-impedance—electrically, they appear to be disconnected or floating. When the CFA-631+SCAB asserts the RESET or POWER\_CONTROL lines, they are momentarily driven high or low (as determined by the RESET\_INVERT and POWER\_INVERT bits, detailed below). To end the power or reset pulse, the CFA-631+SCAB changes the lines back to high-impedance.



## FOUR FUNCTIONS ENABLED BY COMMAND 28

### Function 1: KEYPAD\_RESET

If POWER-ON SENSE (GPIO[1]) is high, pressing the upper right key for 4 seconds will pulse RESET (GPIO[3]) pin for 1 second. During the 1-second pulse, the CFA-631+SCAB will show "RESET", and then the CFA-631+SCAB will reset itself, showing its boot state as if it had just powered on. Once the pulse has finished, the CFA-631+SCAB will not respond to any commands until after it has reset the host and itself.

### Function 2: KEYPAD\_POWER\_ON

If POWER-ON SENSE (GPIO[1]) is low, pressing the upper right key for 0.25 seconds will pulse POWER CONTROL (GPIO[2]) for the duration specified by in data[1] or the default of 1 second. During this time the CFA-631+SCAB will show "POWER ON", then the CFA-631+SCAB will reset itself.

### Function 3: KEYPAD\_POWER\_OFF

If POWER-ON SENSE (GPIO[1]) is high, holding the lower right key key for 4 seconds will pulse POWER CONTROL (GPIO[2]) for the duration specified by in data[1] or the default of 1 second. If the user continues to hold the power key down, then the CFA-631+SCAB will continue to drive the line for a maximum of 5 additional seconds. During this time the CFA-631+SCAB will show "POWER OFF".

### Function 4: LCD\_OFF\_IF\_HOST\_IS\_OFF

If LCD\_OFF\_IF\_HOST\_IS\_OFF is set, the CFA-631+SCAB will blank its screen and turn off its backlight to simulate its power being off any time POWER-ON SENSE (GPIO[1]) is low. The CFA-631+SCAB will still be active (since it is powered by  $V_{SB}$ ), monitoring the keypad for a power-on keystroke. If +12v remains active (which would not be expected, since the host is "off"), the fans will remain on at their previous settings. Once POWER-ON SENSE (GPIO[1]) goes high, the CFA-631+SCAB will reboot as if power had just been applied to it.

```
#define RESET_INVERT          0x02 //Reset pin drives high instead of low
#define POWER_INVERT         0x04 //Power pin drives high instead of low
#define LCD_OFF_IF_HOST_IS_OFF 0x10
#define KEYPAD_RESET         0x20
#define KEYPAD_POWER_ON     0x40
#define KEYPAD_POWER_OFF    0x80

type = 28
data_length = 1 or 2
data[0]: bit mask of enabled functions
data[1]: (optional) length of power on & off pulses in 1/32 second
         1 = 1/32 sec
         2 = 1/16 sec
         16 = 1/2 sec
         255 = 8 sec
```

The return packet will be:

```
type = 0x40 | 28
data_length = 0
```

## 29: Enable/Disable and Reset the Watchdog (SCAB required)

Some high-availability systems use hardware watchdog timers to ensure that a software or hardware failure does not result in an extended system outage. Once the host system has booted, a system monitor program is started. The



system monitor program would enable the watchdog timer on the CFA-631+SCAB. If the system monitor program fails to reset the CFA-631+SCAB's watchdog timer, the CFA-631+SCAB will reset the host system.

#### **NOTE**

The GPIO pins used for ATX control must not be configured as user GPIO. They must be configured to their default drive mode in order for the ATX functions to work correctly. These settings are factory default, but may be changed by the user. Please see the note under command [28: Set ATX Power Switch Functionality \(SCAB required\) \(Pg. 28\)](#) or command [34: Set or Set and Configure GPIO Pin \(Pg. 32\)](#).

```
type = 29
data_length = 1
data[0] = enable/timeout
```

If timeout is 0, the watchdog is disabled.

If timeout is 1-255, then this command must be issued again within timeout seconds to avoid a watchdog reset.

To turn the watchdog off once it has been enabled, simply set timeout to 0.

If the command is not re-issued within timeout seconds, then the CFA-631+SCAB will reset the host (see command 28 for details). Since the watchdog is off by default when the CFA-631+SCAB powers up, the CFA-631+SCAB will not issue another host reset until the host has once again enabled the watchdog.

The return packet will be:

```
type = 0x40 | 29
data_length = 0
```

### **30: Read Reporting & Status**

This command can be used to verify the current items configured to report to the host, as well as some other miscellaneous status information.

```
type = 30
data_length = 0
```

The return packet will be:

```
type = 0x40 | 30
data_length = 15
data[0] = fan 1-4 reporting status (as set by command 16)
data[1] = temperatures 1-8 reporting status (as set by command 19)
data[2] = temperatures 9-15 reporting status (as set by command 19)
data[3] = temperatures 16-23 reporting status (as set by command 19)
data[4] = temperatures 24-32 reporting status (as set by command 19)
data[5] = key presses (as set by command 23)
data[6] = key releases (as set by command 23)
data[7] = ATX Power Switch Functionality (as set by command 28), and
        bit 0x08 will be set if the watchdog is active
data[8] = current watchdog counter (as set by command 29)
data[9] = fan RPM glitch delay[0] (as set by command 26)
data[10] = fan RPM glitch delay[1] (as set by command 26)
data[11] = fan RPM glitch delay[2] (as set by command 26)
data[12] = fan RPM glitch delay[3] (as set by command 26)
data[13] = contrast setting (as set by command 13)
data[14] = backlight setting (as set by command 14)
```

Please Note: Previous and future firmware versions may return fewer or additional bytes.



### 31: Send Data to LCD

This command allows data to be placed at any position on the LCD.

```
type = 31
data_length = 3 to 22
data[0]: col = x = 0 to 19
data[1]: row = y = 0 to 1
data[2-21]: text to place on the LCD, variable from 1 to 20 characters
```









The return packet will be:

```
type = 0x40 | 31
data_length = 0
```

Send Data to LCD is one of the items stored by the command [4: Store Current State As Boot State \(Pg. 16\)](#).

### 32: Key Legends

The CFA-631 offers firmware support for “soft keys”. Eight predefined icons correspond to common key functions:

```
#define KEY_LEGEND_BLANK      0 
#define KEY_LEGEND_CANCEL    1 
#define KEY_LEGEND_CHECK     2 
#define KEY_LEGEND_UP        3 
#define KEY_LEGEND_DOWN      4 
#define KEY_LEGEND_RIGHT     5 
#define KEY_LEGEND_LEFT      6 
#define KEY_LEGEND_PLUS      7 
#define KEY_LEGEND_MINUS     8 
#define KEY_LEGEND_NONE      9 //no key or symbol
```

The host simply enables key legends—specifying the icon to display corresponding to each key—and then the CFA-631 firmware draws the legends. Each soft-key legend “inverts” when the corresponding hard key is pressed, providing instant feedback that the key has been actuated.

The key legends use special characters 2,3,4,5,6 and 7. Special characters 0 and 1 are available for other functions.

The key legends act as a second layer of the display over the 6 rightmost characters. Text written to the key legends area are overwritten instantly by the key legends.

```
type = 32
data_length = 1 (to disable) or 5 (to enable and specify)
data[0]: enable = 1, disable = 0
data[1] = code for icon to be displayed for upper-left key
data[2] = code for icon to be displayed for upper-right key
data[3] = code for icon to be displayed for lower-left key
data[4] = code for icon to be displayed for lower-right key
```

The return packet will be:

```
type = 0x40 | 32
data_length = 0
```

The key reports are not affected by the key legend settings. The host should make the appropriate action based on the key legend settings and the keys reported.



By using special character definitions and key reports, the functionality of the key legends can be emulated in host software, allowing unlimited icon definitions.

Key Legends is one of the items stored by the command [4: Store Current State As Boot State \(Pg. 16\)](#).

### 33: Set Baud Rate

This command will change the CFA-631's baud rate. The CFA-631 will send the acknowledge packet for this command and change its baud rate to the new value. The host should send the baud rate command, wait for a positive acknowledge from the CFA-631 at the old baud rate, and then switch itself to the new baud rate. The baud rate must be saved by the command [4: Store Current State As Boot State \(Pg. 16\)](#) if you want the CFA-631 to power up at the new baud rate.

The factory default baud rate is 115200.

```
type = 33
data_length = 1
data[0]: 0 = 19200 baud
         1 = 115200 baud
```

The return packet will be:

```
type = 0x40 | 33
data_length = 0
```

### 34: Set or Set and Configure GPIO Pin

The CFA-631 (hardware versions v2.0 and up, firmware versions 2.0 and up) has five pins for user-definable general purpose input / output (GPIO). These pins are shared with the DOW and ATX functions. Be careful when you configure the GPIOs if you want to use the ATX or DOW at the same time.

The architecture of the CFA-631 allows great flexibility in the configuration of the GPIO pins. They can be set as input or output. They can output constant high or low signals or a variable duty cycle 100 Hz PWM signal.

In output mode using the PWM (and a suitable current limiting resistor), an LED may be turned on or off and even dimmed under host software control. With suitable external circuitry, the GPIOs can also be used to drive external logic or power transistors.

The CFA-631 continuously polls the GPIOs as inputs at 32 Hz. The present level can be queried by the host software at a lower rate. The CFA-631 also keeps track of whether there were rising or falling edges since the last host query (subject to the resolution of the 32 Hz sampling). This means that the host is not forced to poll quickly in order to detect short events. The algorithm used by the CFA-631 to read the inputs is inherently "bounce-free".

The GPIOs also have "pull-up" and "pull-down" modes. These modes can be useful when using the GPIO as an input connected to a switch since no external pull-up or pull-down resistor is needed. For instance, the GPIO can be set to pull up. Then when a switch connected between the GPIO and ground is open, reading the GPIO will return a "1". When the switch is closed, the input will return a "0".

Pull-up/pull-down resistance values are approximately 5kΩ. Do not exceed current of 25 mA per GPIO.





**NOTE ON SETTING AND CONFIGURING GPIO PINS**

The GPIO pins may also be used for ATX control through the SCAB's header J8 and temperature sensing through the SCAB's DOW header. By factory default, the GPIO output setting, function, and drive mode are set correctly to enable operation of the ATX and DOW functions. **The GPIO output setting, function, and drive mode must be set to the correct values in order for the ATX and DOW functions to work. Improper use of this command can disable the ATX and DOW functions.** The [631\\_WinTest](#) may be used to easily check and reset the GPIO configuration to the default state so the ATX and DOW functions will work.

The GPIO configuration is one of the items stored by the command [4: Store Current State As Boot State \(Pg. 16\)](#).

```
type: 34
data_length:
  2 bytes to change value only
  3 bytes to change value and configure function and drive mode
```

```
data[0]: index of GPIO to modify
0 = GPIO[0] = J8, Pin 7
1 = GPIO[1] = J8, Pin 6 (default is ATX Host Power Sense)
2 = GPIO[2] = J8, Pin 5 (default is ATX Host Power Control)
3 = GPIO[3] = J8, Pin 4 (default is ATX Host Reset Control)
4 = GPIO[4] = J9, Pin 2 (default is DOW I/O--always has 1KΩ hardware pull-up)
5-255: reserved
```

Please note: Future versions of this command on future hardware models may accept additional values for data[0], which would control the state of future additional GPIO pins

```
data[1] = Pin output state (actual behavior depends on drive mode):
  0 = Output set to low
  1-99: Output duty cycle percentage (100 Hz nominal)
  100 = Output set to high
  101-255: invalid
```

```
data[2] = Pin function select and drive mode (optional)
---- FDDD
| | | | -- DDD = Drive Mode (based on output state of 1 or 0)
| | | | =====
| | | | 000: 1=Fast, Strong Drive Up, 0=Resistive Pull Down
| | | | 001: 1=Fast, Strong Drive Up, 0=Fast, Strong Drive Down
| | | | 010: Hi-Z, use for input
| | | | 011: 1=Resistive Pull Up, 0=Fast, Strong Drive Down
| | | | 100: 1=Slow, Strong Drive Up, 0=Hi-Z
| | | | 101: 1=Slow, Strong Drive Up, 0=Slow, Strong Drive Down
| | | | 110: reserved, do not use
| | | | 111: 1=Hi-Z, 0=Slow, Strong Drive Down
| | | |
| | | | ----- F = Function
| | | | =====
| | | | 0: Port unused for GPIO. It will take on the default
| | | | function such as ATX, DOW or unused. The user is
| | | | responsible for setting the drive to the correct
| | | | value in order for the default function to work
| | | | correctly.
| | | | 1: Port used for GPIO under user control. The user is
| | | | responsible for setting the drive to the correct
| | | | value in order for the desired GPIO mode to work
| | | | correctly.
| | | | ----- reserved, must be 0
```



The return packet will be:

```
type = 0x40 | 34  
data_length = 0
```

### 35: Read GPIO Pin Levels and Configuration State

Please see command [34: Set or Set and Configure GPIO Pin \(Pg. 32\)](#) for details on the GPIO architecture.

```
type: 35  
data_length: 4  
  
data[0]: index of GPIO to query  
0 = GPIO[0] = J8, Pin 7  
1 = GPIO[1] = J8, Pin 6 (default is ATX Host Power Sense)  
2 = GPIO[2] = J8, Pin 5 (default is ATX Host Power Control)  
3 = GPIO[3] = J8, Pin 4 (default is ATX Host Reset Control)  
4 = GPIO[4] = J9, Pin 2 (default is DOW I/O--always has 1K $\Omega$   
hardware pull-up)  
  
5-255: reserved
```

Please note: Future versions of this command on future hardware models may accept additional values for data[0], which would return the status of future additional GPIO pins

(Continues on the next page.)



returns:

```

data[0] = index of GPIO read
data[1] = Pin state & changes since last poll
-----RFS Enable Reporting of this Fan's Tach Input
|||||  |||  |-- S = state at the last reading
|||||  |||  |-- F = at least one falling edge has
|||||  |||  |    been detected since the last poll
|||||  |||  |-- R = at least one rising edge has
|||||  |||  |    been detected since the last poll
|||||  |||  ----- reserved
  
```

(This reading is the actual pin state, which may or may not agree with the pin setting, depending on drive mode and the load presented by external circuitry. The pins are polled at approximately 32 Hz asynchronously with respect to this command. Transients that happen between polls will not be detected.)

```

data[2] = Requested Pin level/PWM level
0-100: Output duty cycle percentage
(This value is the requested PWM duty cycle. The actual pin may or may not be toggling in agreement with this value, depending on the drive mode and the load presented by external circuitry)
  
```

```

data[3] = Pin function select and drive mode
  
```

```

----- FDDD
|||||  |||  |-- DDD = Drive Mode
|||||  |||  |=====
|||||  |||  |000: 1=Fast, Strong Drive Up, 0=Resistive Pull Down
|||||  |||  |001: 1=Fast, Strong Drive Up, 0=Fast, Strong Drive Down
|||||  |||  |010: Hi-Z, use for input
|||||  |||  |011: 1=Resistive Pull Up,      0=Fast, Strong Drive Down
|||||  |||  |100: 1=Slow, Strong Drive Up, 0=Hi-Z
|||||  |||  |101: 1=Slow, Strong Drive Up, 0=Slow, Strong Drive Down
|||||  |||  |110: reserved
|||||  |||  |111: 1=Hi-Z,                    0=Slow, Strong Drive Down
|||||  |||  |
|||||  |||  |----- F = Function
|||||  |||  |=====
|||||  |||  |0: Port unused for GPIO. It will take on the default
|||||  |||  |   function such as ATX, DOW or unused. The user is
|||||  |||  |   responsible for setting the drive to the correct
|||||  |||  |   value in order for the default function to work
|||||  |||  |   correctly.
|||||  |||  |1: Port used for GPIO under user control. The user is
|||||  |||  |   responsible for setting the drive to the correct
|||||  |||  |   value in order for the desired GPIO mode to work
|||||  |||  |   correctly.
|||||  |||  |----- reserved, will return 0
  
```



# CHARACTER GENERATOR ROM (CGROM)

To find the code for a given character, add the two numbers that are shown in bold for its row and column. For example, the superscript "9" is in the column labeled "128<sub>d</sub>" and in the row labeled "9<sub>d</sub>". So you would add 128 + 9 to get 137. When you send a byte with the value of 137 to the display, then a superscript "9" will be shown.

upper 4 bits lower 4 bits	0 <sub>d</sub> 0000.	16 <sub>d</sub> 0001.	32 <sub>d</sub> 0010.	48 <sub>d</sub> 0011.	64 <sub>d</sub> 0100.	80 <sub>d</sub> 0101.	96 <sub>d</sub> 0110.	112 <sub>d</sub> 0111.	128 <sub>d</sub> 1000.	144 <sub>d</sub> 1001.	160 <sub>d</sub> 1010.	176 <sub>d</sub> 1011.	192 <sub>d</sub> 1100.	208 <sub>d</sub> 1101.	224 <sub>d</sub> 1110.	240 <sub>d</sub> 1111.
0 <sub>d</sub> 0000.	<b>CGRAM</b> <b>[0]</b>															
1 <sub>d</sub> 0001.	<b>CGRAM</b> <b>[1]</b>															
2 <sub>d</sub> 0010.	<b>CGRAM</b> <b>[2]</b>															
3 <sub>d</sub> 0011.	<b>CGRAM</b> <b>[3]</b>															
4 <sub>d</sub> 0100.	<b>CGRAM</b> <b>[4]</b>															
5 <sub>d</sub> 0101.	<b>CGRAM</b> <b>[5]</b>															
6 <sub>d</sub> 0110.	<b>CGRAM</b> <b>[6]</b>															
7 <sub>d</sub> 0111.	<b>CGRAM</b> <b>[7]</b>															
8 <sub>d</sub> 1000.	<b>CGRAM</b> <b>[0]</b>															
9 <sub>d</sub> 1001.	<b>CGRAM</b> <b>[1]</b>															
10 <sub>d</sub> 1010.	<b>CGRAM</b> <b>[2]</b>															
11 <sub>d</sub> 1011.	<b>CGRAM</b> <b>[3]</b>															
12 <sub>d</sub> 1100.	<b>CGRAM</b> <b>[4]</b>															
13 <sub>d</sub> 1101.	<b>CGRAM</b> <b>[5]</b>															
14 <sub>d</sub> 1110.	<b>CGRAM</b> <b>[6]</b>															
15 <sub>d</sub> 1111.	<b>CGRAM</b> <b>[7]</b>															

Figure 5. Character Generator ROM (CGROM)



# CFA-631 MODULE OUTLINE DRAWING

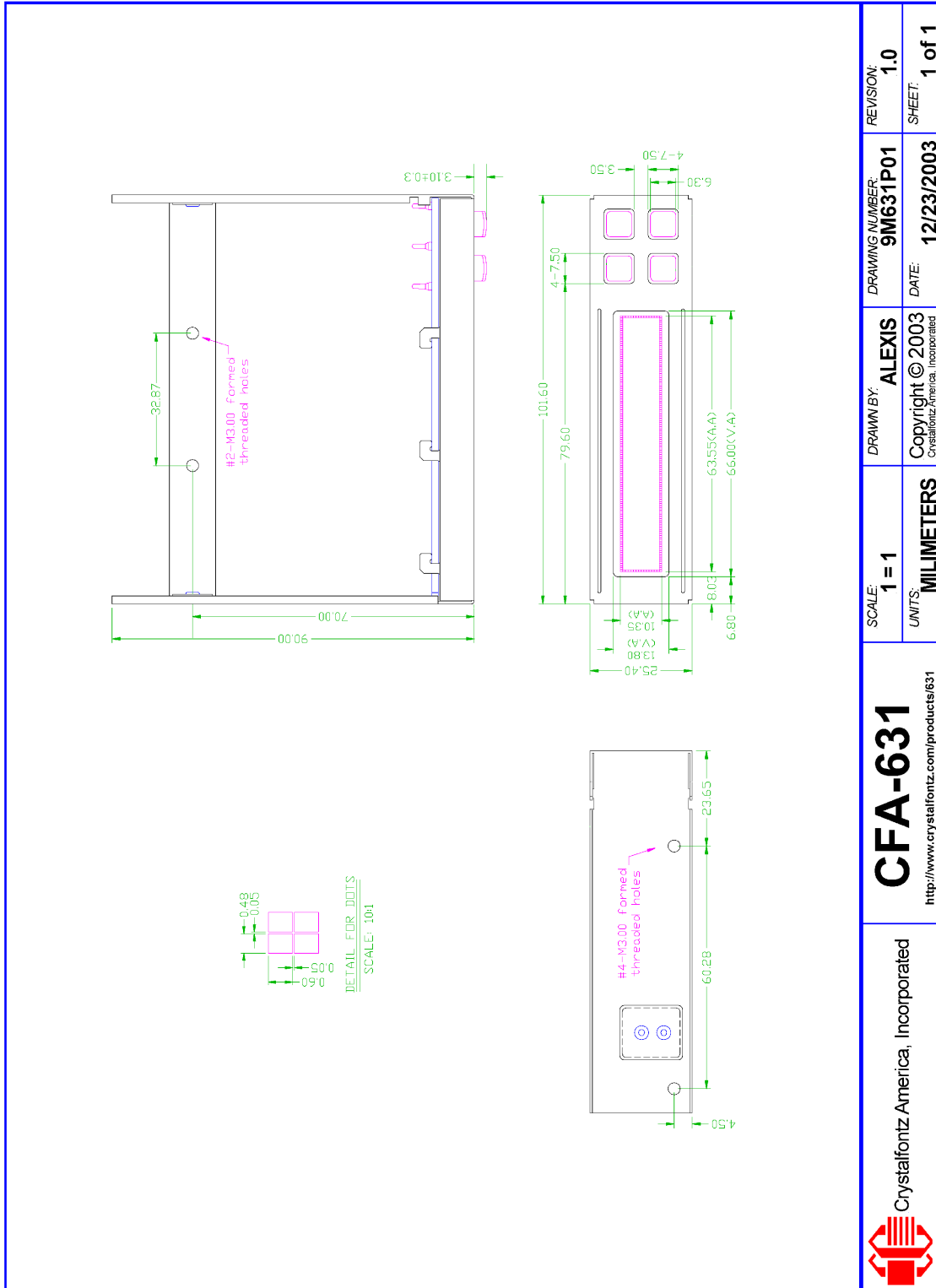

Figure 6. CFA-631 Module Outline Drawing (v2.0 identical to v1.0)



# JUMPER LOCATIONS AND FUNCTIONS

The CFA-631 has four jumpers. Only JP2 and JPB may be changed. The jumpers are normally open. The jumpers may be closed by melting a ball of solder across their gap. You may re-open the jumpers by removing the solder. Solder wick works well for this.

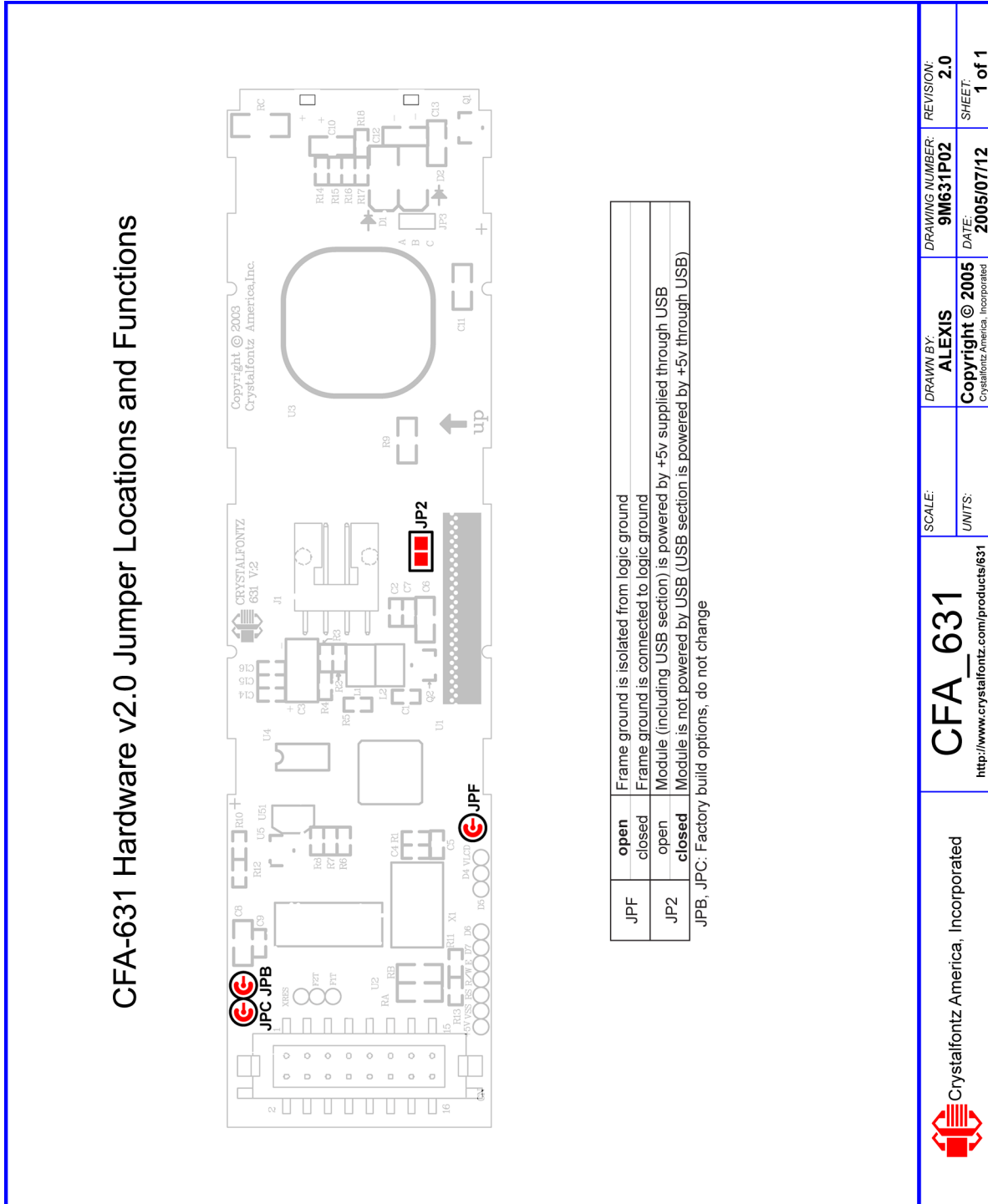

Figure 7. CFA-631 Hardware v2.0 Jumper Locations and Functions



## CARE AND HANDLING PRECAUTIONS

---

For optimum operation of the CFA631-RMF-KU and to prolong its life, please follow the precautions described below.

### ELECTROSTATIC DISCHARGE (ESD)

Please use industry standard antistatic precautions as you would for any other PCB such as expansion cards or motherboards. Ground your body, work surfaces, and equipment.

### DESIGN AND MOUNTING

- To protect the polarizer from damage, the CFA631-RMF-KU ships with a protective film over the LCD glass. Please peel off the protective film slowly. Peeling off the protective film abruptly may generate static electricity.
- If you are not using a Crystalfontz overlay, place a transparent plate (for example, acrylic, polycarbonate, or glass) in front of the CFA631-RMF-KU, leaving a small gap between the plate and the display surface. We use GE HP-92 Lexan, which is readily available and works well.
- Do not disassemble or modify the CFA631-RMF-KU. Do not make any solder connections to the module—use the appropriate mating connectors.
- Do not reverse polarity to the power supply connections. Reversing the polarity will immediately ruin the module.

### AVOID SHOCK, IMPACT, TORQUE, AND TENSION

- Do not expose the CFA631-RMF-KU to strong mechanical shock, impact, torque, and tension.
- Do not drop, toss, bend, or twist the CFA631-RMF-KU.
- Do not place weight or pressure on the CFA631-RMF-KU.

### IF LCD PANEL BREAKS

- If the LCD panel breaks, be careful to not get the liquid crystal fluid in your mouth or eyes.
- If the liquid crystal fluid touches your skin, clothes, or work surface, wash it off immediately using soap and plenty of water.
- Do not eat the LCD panel.

### CLEANING

- To clean the front of the LCD panel or a Crystalfontz overlay, a standard household glass cleaner works well. Gently wipe with a nonabrasive soft cloth.
- *CFA631-RMF-KU without Crystalfontz overlay:* The exposed surface of the LCD “glass” is actually the front polarizer laminated to the glass. The polarizer is made out of a fairly soft plastic and is easily scratched or damaged. The polarizer will eventually become hazy if you do not take great care when cleaning it. Long contact with moisture (from condensation or cleaning) may permanently spot or stain the polarizer.



## OPERATION

- Your circuit should be designed to protect the CFA631-RMF-KU from ESD and power supply transients.
- Observe the operating temperature limitations: a minimum of 0°C to a maximum of 50°C with minimal fluctuation. Operation outside of these limits may shorten life and/or harm display.
  - At lower temperatures of this range, response time is delayed.
  - At higher temperatures of this range, display becomes dark. (You may need to adjust the contrast.)
- Operate away from dust, moisture, and direct sunlight.

## STORAGE

- Store in an ESD-approved container away from dust, moisture, and direct sunlight.
- -10°C minimum, 60°C maximum with minimal fluctuation. Rapid temperature changes can cause moisture to form, resulting in permanent damage.
- Do not allow weight to be placed on the CFA631-RMF-KUs while they are in storage.





## APPENDIX A: CONNECTING A DS2450 1-WIRE QUAD A/D CONVERTER (SCAB REQUIRED)

This appendix describes a simple test circuit that demonstrates how to connect a Dallas Semiconductor DS2450 4-channel ADC to the SCAB's "DOW" (Dallas One Wire) connector. It also gives a sample command sequence to initialize and read the ADC.

Up to 32 DOW devices can be connected to the CFA-631+SCAB. In this example the DS2450 appears at device index 0. Your software should query the connected devices using command [18: Read DOW Device Information \(SCAB required\) \(Pg. 21\)](#) to verify the locations and types of DOW devices connected in your application.

Please refer to the [DS2450 Data Sheet](#) and the description for command [20: Arbitrary DOW Transaction \(SCAB required\) \(Pg. 23\)](#) more information.

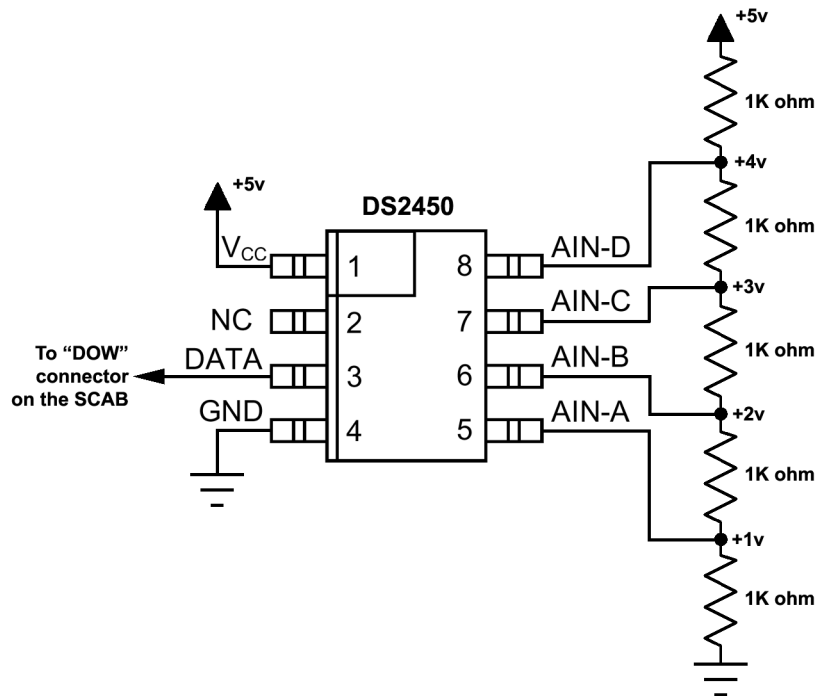

Appendix A Figure 1. CFA-631 Test Circuit Schematic

Start [631\\_WinTest](#) and open the Packet Debugger dialog.

Select Command 20 = Arbitrary DOW Transaction, then paste each string below into the data field and send the packet. The response should be similar to what is shown.



```
//Write 0x40 (=64) to address 0x1C (=28) to leave analog circuitry on
//(see page 6 of the data sheet)
<command 20> \000\002\085\028\000\064
<response> C=84(d=0):2E,05,22 //16 bit "i-button" CRC + 8-bit "DOW" CRC
//Consult "i-button" docs to check 16-bit CRC
//DOW CRC is probably useless for this device.

//Write all 8 channels of control/status (16 bits, 5.10v range)
<command 20> \000\002\085\008\000\000 // address = 8, channel A low
<response> C=84(d=0):6F,F1,68 // 16-bits, output off

<command 20> \000\002\085\009\000\001 // address = 9, channel A high
<response> C=84(d=0):FF,F1,AB // no alarms, 5.1v

<command 20> \000\002\085\010\000\000 // address = 10, channel B low
<response> C=84(d=0):CE,31,88 // 16-bits, output off

<command 20> \000\002\085\011\000\001 // address = 11, channel B high
<response> C=84(d=0):5E,31,4B // no alarms, 5.1v

<command 20> \000\002\085\012\000\000 // address = 12, channel C low
<response> C=84(d=0):2E,30,A3 // 16-bits, output off

<command 20> \000\002\085\013\000\001 // address = 13, channel C high
<response> C=84(d=0):BE,30,60 // no alarms, 5.1v

<command 20> \000\002\085\014\000\000 // address = 14, channel D low
<response> C=84(d=0):8F,F0,43 // 16-bits, output off

<command 20> \000\002\085\015\000\001 // address = 15, channel D high
<response> C=84(d=0):1F,F0,80 // no alarms, 5.1v

//Read all 4 channels of control/status (check only)
<command 20> \000\010\170\008\000
<response> C=84(d=0):00,01,00,01,00,01,00,01,E0,CF,01

//Repeat next two commands for each conversion (two cycles shown)

//Start conversion on all channels
<command 20> \000\002\060\015\000
<response> C=84(d=0):3A,03,28

//Read all 8 channels
<command 20> \000\010\170\000\000
<response> C=84(d=0):00,33,DF,64,84,96,6A,C8,5A,6B,BE

//Decoded response:
0x3300 = 130561.016015625 volts (channel A)
0x64DF = 258232.009541321 volts (channel B)
0x9684 = 385322.998553467 volts (channel C)
0xC86A = 513063.992623901 volts (channel D)

//Start conversion on all channels
<command 20> \000\002\060\015\000
<response> C=84(d=0):3A,03,28

//Read all 8 channels
<command 20> \000\010\170\000\000
<response> C=84(d=0):6B,33,B2,64,97,96,42,C8,0F,C9,0A

//Decoded response:
0x336B = 131631.024342346 volts (channel A)
0x64B2 = 257782.006039429 volts (channel B)
0x9697 = 385513.000032043 volts (channel C)
0xC842 = 512663.989511108 volts (channel D)
```



## APPENDIX B: CONNECTING A DS1963S SHA IBUTTON (SCAB REQUIRED)

---

This appendix describes connecting a Dallas Semiconductor DS1963S Monetary iButton with SHA-1 Challenge Response Algorithm and 4KB of nonvolatile RAM to the CFA-631+SCAB's DOW (Dallas One Wire) connector. It also gives a sample command sequence to read and write the DS1963S's scratch memory.

The DS1963S can be used as a secure dongle to protect your system's application software from being copied. Even if the communication channel is compromised or the host is not authentic, the SHA algorithm ensures that the data is still secure. Please see the following Maxim/Dallas white papers and application notes for more information:

- [White Paper 1: SHA Devices Used in Small Cash Systems](#)
- [White Paper 2: Using the 1-Wire Public-Domain Kit](#)
- [White Paper 3: Why are 1-Wire SHA-1 Devices Secure?](#)
- [White Paper 4: Glossary of 1-Wire SHA-1 Terms](#)
- [App Note 1201: White Paper 8: 1-Wire SHA-1 Overview](#)
- [App Note 150: Small Message Encryption using SHA Devices](#)
- [App Note 152: SHA iButton Secrets and Challenges](#)
- [App Note 154: Passwords in SHA Authentication](#)
- [App Note 156: DS1963S SHA 1-Wire API Users Guide](#)
- [App Note 157: SHA iButton API Overview](#)
- [App Note 190: Challenge and Response with 1-Wire SHA devices](#)

Up to 32 DOW devices can be connected to the CFA-631+SCAB. In this example the DS1963S appears at device index 0. Your software should query the connected devices using command [18: Read DOW Device Information \(SCAB required\) \(Pg. 21\)](#) to verify the locations and types of DOW devices connected in your application.

Please refer to the [DS1963S Data Sheet](#) and the description for command [20: Arbitrary DOW Transaction \(SCAB required\) \(Pg. 23\)](#) for more information.

To connect the DS1963S to the CFA-631+SCAB, simply make one connection between the DS1963S's "GND" terminal and the CFA-631+SCAB DOW connector's GND pin, and a second connection between the DS1963S's "IO" pin and the CFA-631+SCAB DOW connector's I/O pin. By using a DS9094 iButton Clip, the connection is easy.

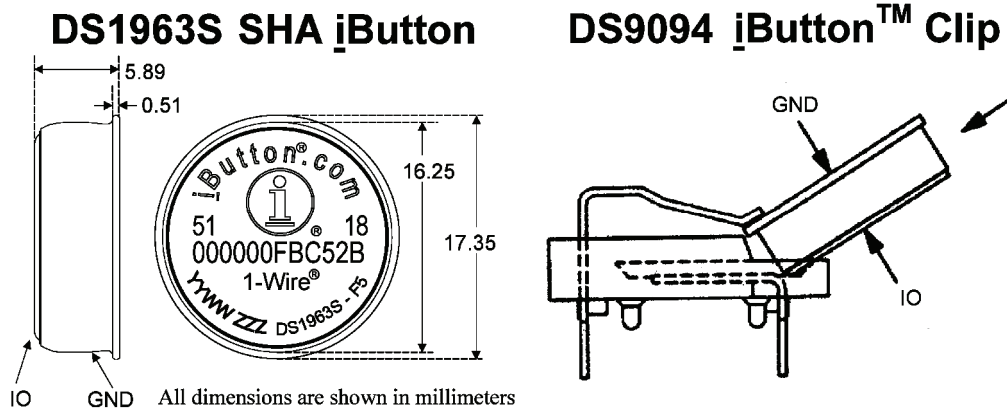

Appendix B Figure 1. Connect CFA-631 to Maxim/Dallas DS19632 SHA iButton using DS9094 iButton Clip

To demonstrate reading and writing the scratch memory on DS1963S, open the [631\\_WinTest](#) Packet Debugger dialog and use it to experiment with the following commands: Erase Scratchpad, Read Scratchpad, and Write Scratchpad.

To use the full power of the DS1963S, a program based on the Dallas/Maxim application notes listed above is needed. The challenge/response sequence would be unwieldy to demonstrate using the 631\_WinTest Packet Debugger dialog.

First read the address of the DS1963S as detected by the CFA-631 at boot. Since only one device is connected, you only need to query index 0. In a production situation, query all 32 indices to get a complete picture of the devices available on the DOW bus.

```
Command:
  18 = Read DOW Device Information
Data sent:
  \000
Data received:
  C=82 (d=0) : 18, CC, D2, 19; 00, 00, 00, 9E
```

The first byte returned is the Family Code of the Dallas One Wire / iButton device. 0x18 indicates that this device is a DS1963. A list of the possible Dallas One Wire / iButton device family codes is available in [App Note 155: 1-Wire Software Resource Guide](#) on the Maxim/Dallas web site.

Erase Scratchpad Command (quote from the Maxim/Dallas [DS1963S Data Sheet](#)):

*Erase Scratchpad [C3h]*  
*The purpose of this command is to clear the HIDE flag and to wipe out data that might have been left in the scratchpad from a previous operation. After having issued the command code the bus master transmits a target address, as with the write scratchpad command, but no data. Next the whole scratchpad will be automatically filled with FFh bytes, regardless of the target address. This process takes approximately 32 μs during which the master reads 1's. After this the master reads a pattern of alternating 0's and 1's indicating that the command has completed. The master must read at least 8 bits of this alternating pattern. Otherwise the device might not properly respond to a subsequent Reset Pulse.*

```
Command:
  20 = Arbitrary DOW transaction
Data sent:
  \000\014\xC3\000\000
Data received:
  C=84 (d=0) : FF, AA, AA, AA, AA, AA, AA, AA, AA, AA, AA, AA, AA, AA, AA, 9F
```

The "AA" bytes read are the pattern of alternating 0's and 1's indicating that the command has completed.



Read Scratchpad Command (quote from the Maxim/Dallas [DS1963S Data Sheet](#))

*Read Scratchpad Command [AAh]*

*HIDE = 0:*

*The Read Scratchpad command allows verifying the target address, ending offset and the integrity of the scratchpad data. After issuing the command code the master begins reading. The first 2 bytes will be the target address. The next byte will be the ending offset/data status byte (E/S) followed by the scratchpad data beginning at the byte offset (T4: T0). The master may read data until the end of the scratchpad after which it will receive the inverted CRC generated by the DS1963S. If the master continues reading after the CRC all data will be logic 1's.*

**Command:**

20 = Arbitrary DOW transaction

**Data sent:**

\000\014\xAA

**Data received:**

C=84 (d=0) : 00, 00, 1F, FF, FF, FF, FF, FF, FF, FF, FF, FF, FF, 07

Since you did an "Erase Scratchpad" as the previous command, the "Read Scratchpad" returns 0xFF bytes as expected.

Write Scratchpad Command (quote from the Maxim/Dallas [DS1963S Data Sheet](#))

*Write Scratchpad Command [0Fh]*

*HIDE = 0, Target Address range 0000h to 01FFh only*

*After issuing the write scratchpad command, the master must first provide the 2-byte target address, followed by the data to be written to the scratchpad. The data will be written to the scratchpad starting at the byte offset (T4:T0). The ending offset (E4: E0) will be the byte offset at which the master stops writing data. Only full data bytes are accepted. If the last data byte is incomplete its content will be ignored and the partial byte flag PF will be set.*

*When executing the Write Scratchpad command the CRC generator inside the DS1963S (see Figure 12) calculates a CRC of the entire data stream, starting at the command code and ending at the last data byte sent by the master. This CRC is generated using the CRC16 polynomial by first clearing the CRC generator and then shifting in the command code (0FH) of the Write Scratchpad command, the Target Addresses TA1 and TA2 as supplied by the master and all the data bytes. The master may end the Write Scratchpad command at any time. However, if the ending offset is 11111b, the master may send 16 read time slots and will receive the CRC generated by the DS1963S.*

Write 10 bytes of identifiable test data {0x11, 0x22, 0x33, 0x44, 0x55, 0x66, 0x77, 0x88, 0x99, 0xAA} to the scratch pad in location 0:0

**Command:**

20 = Arbitrary DOW transaction

**Data sent:**

\000\000\x0F\x00\x00\x11\x22\x33\x44\x55\x66\x77\x88\x99\xAA

**Data received:**

C=84 (d=0) : 00

Use the Read Scratchpad Command [AAh] to read back the data.

**Command:**

20 = Arbitrary DOW transaction

**Data sent:**

\000\013\xAA

**Data received:**

C=84 (d=0) : 00, 00, 09, 11, 22, 33, 44, 55, 66, 77, 88, 99, AA, 1E



Now write 10 bytes of identifiable test data {0x12, 0x23, 0x34, 0x45, 0x56, 0x67, 0x78, 0x89, 0x9A, 0xAB} to the scratch pad in location 0:0x0A

```
Command:
  20 = Arbitrary DOW transaction
Data sent:
  \000\000\x0F\x0A\x00\x12\x23\x34\x45\x56\x67\x78\x89\x9A\xAB
Data received:
  C=84 (d=0) : 00
```

Use the Read Scratchpad Command [AAh] to read back the data.

```
Command:
  20 = Arbitrary DOW transaction
Data sent:
  \000\013\xAA
Data received:
  C=84 (d=0) : 00, 02, 09, 12, 23, 34, 45, 56, 67, 78, 89, 9A, AB, 62
```

Reading and writing to the scratch pad is the first step required to communicate with the DS1863S. In order to fully use the DS1863S for a dongle application that securely protects your software from copying, become familiar with the SHA algorithm as it applies to the SHA iButton by studying the Maxim/Dallas white papers and application notes listed above. Then create a software application that implements the secure challenge/response protocol as outlined in the application notes.



## APPENDIX C: CALCULATING THE CRC

Below are five sample algorithms that will calculate the CRC of a CFA-631 packet. Some of the algorithms were contributed by forum members and originally written for the CFA-633. The CRC used in the CFA-631 is the same one that is used in IrDA, which came from PPP, which to at least some extent seems to be related to a CCITT (ref: Network Working Group Request for Comments: 1171) standard. At that point, the trail was getting a bit cold and diverged into several referenced articles and papers, dating back to 1983.

The polynomial used is  $X^{16} + X^{12} + X^5 + X^0$  (0x8408)  
 The result is bit-wise inverted before being returned.

### ALGORITHM 1: "C" TABLE IMPLEMENTATION

This algorithm is typically used on the host computer, where code space is not an issue.

```
//This code is from the IRDA LAP documentation, which appears to
//have been copied from PPP:
//
// http://irda.affiniscape.com/associations/2494/files/Specifications/
IrLAP11_Plus_Errata.zip
//
//I doubt that there are any worries about the legality of this code,
//searching for the first line of the table below, it appears that
//the code is already included in the linux 2.6 kernel "Driver for
//ST5481 USB ISDN modem". This is an "industry standard" algorithm
//and I do not think there are ANY issues with it at all.
word get_crc(ubyte *bufptr,word len)
{
  //CRC lookup table to avoid bit-shifting loops.
  static const word crcLookupTable[256] =
  {
    0x00000,0x01189,0x02312,0x0329B,0x04624,0x057AD,0x06536,0x074BF,
    0x08C48,0x09DC1,0x0AF5A,0x0BED3,0x0CA6C,0x0DBE5,0x0E97E,0x0F8F7,
    0x01081,0x00108,0x03393,0x0221A,0x056A5,0x0472C,0x075B7,0x0643E,
    0x09CC9,0x08D40,0x0BFDB,0x0AE52,0x0DAED,0x0CB64,0x0F9FF,0x0E876,
    0x02102,0x0308B,0x00210,0x01399,0x06726,0x076AF,0x04434,0x055BD,
    0x0AD4A,0x0BCC3,0x08E58,0x09FD1,0x0EB6E,0x0FAE7,0x0C87C,0x0D9F5,
    0x03183,0x0200A,0x01291,0x00318,0x077A7,0x0662E,0x054B5,0x0453C,
    0x0BDCB,0x0AC42,0x09ED9,0x08F50,0x0FBEF,0x0EA66,0x0D8FD,0x0C974,
    0x04204,0x0538D,0x06116,0x0709F,0x00420,0x015A9,0x02732,0x036BB,
    0x0CE4C,0x0DFC5,0x0ED5E,0x0FCD7,0x08868,0x099E1,0x0AB7A,0x0BAF3,
    0x05285,0x0430C,0x07197,0x0601E,0x014A1,0x00528,0x037B3,0x0263A,
    0x0DECD,0x0CF44,0x0FDDF,0x0EC56,0x098E9,0x08960,0x0BBFB,0x0AA72,
    0x06306,0x0728F,0x04014,0x0519D,0x02522,0x034AB,0x00630,0x017B9,
    0x0EF4E,0x0FEC7,0x0CC5C,0x0DDD5,0x0A96A,0x0B8E3,0x08A78,0x09BF1,
    0x07387,0x0620E,0x05095,0x0411C,0x035A3,0x0242A,0x016B1,0x00738,
    0x0FFCF,0x0EE46,0x0DCDD,0x0CD54,0x0B9EB,0x0A862,0x09AF9,0x08B70,
    0x08408,0x09581,0x0A71A,0x0B693,0x0C22C,0x0D3A5,0x0E13E,0x0F0B7,
    0x00840,0x019C9,0x02B52,0x03ADB,0x04E64,0x05FED,0x06D76,0x07CFF,
    0x09489,0x08500,0x0B79B,0x0A612,0x0D2AD,0x0C324,0x0F1BF,0x0E036,
    0x018C1,0x00948,0x03BD3,0x02A5A,0x05EE5,0x04F6C,0x07DF7,0x06C7E,
    0x0A50A,0x0B483,0x08618,0x09791,0x0E32E,0x0F2A7,0x0C03C,0x0D1B5,
    0x02942,0x038CB,0x00A50,0x01BD9,0x06F66,0x07EEF,0x04C74,0x05DFD,
    0x0B58B,0x0A402,0x09699,0x08710,0x0F3AF,0x0E226,0x0D0BD,0x0C134,
    0x039C3,0x0284A,0x01AD1,0x00B58,0x07FE7,0x06E6E,0x05CF5,0x04D7C,
    0x0C60C,0x0D785,0x0E51E,0x0F497,0x08028,0x091A1,0x0A33A,0x0B2B3,
    0x04A44,0x05BCB,0x06956,0x078DF,0x00C60,0x01DE9,0x02F72,0x03EFB,
    0x0D68D,0x0C704,0x0F59F,0x0E416,0x090A9,0x08120,0x0B3BB,0x0A232,
    0x05AC5,0x04B4C,0x079D7,0x0685E,0x01CE1,0x00D68,0x03FF3,0x02E7A,
    0x0E70E,0x0F687,0x0C41C,0x0D595,0x0A12A,0x0B0A3,0x08238,0x093B1,
    0x06B46,0x07ACF,0x04854,0x059DD,0x02D62,0x03CEB,0x00E70,0x01FF9,
    0x0F78F,0x0E606,0x0D49D,0x0C514,0x0B1AB,0x0A022,0x092B9,0x08330,
```



```
0x07BC7, 0x06A4E, 0x058D5, 0x0495C, 0x03DE3, 0x02C6A, 0x01EF1, 0x00F78};

register word
newCrc;
newCrc=0xFFFF;
//This algorithm is based on the IrDA LAP example.
while(len--)
    newCrc = (newCrc >> 8) ^ crcLookupTable[(newCrc ^ *bufptr++) & 0xff];

//Make this crc match the one's complement that is sent in the packet.
return(~newCrc);
}
```

## ALGORITHM 2: "C" BIT SHIFT IMPLEMENTATION

This algorithm was mainly written to avoid any possible legal issues about the source of the routine (at the request of the LCDproc group). This routine was "clean" coded from the definition of the CRC. It is ostensibly smaller than the table driven approach but will take longer to execute. This routine is offered under the GPL.

```
word get_crc(ubyte *bufptr, word len)
{
    register unsigned int
        newCRC;
    //Put the current byte in here.
    ubyte
        data;
    int
        bit_count;
    //This seed makes the output of this shift based algorithm match
    //the table based algorithm. The center 16 bits of the 32-bit
    //"newCRC" are used for the CRC. The MSB of the lower byte is used
    //to see what bit was shifted out of the center 16 bit CRC
    //accumulator ("carry flag analog");
    newCRC=0x00F32100;
    while(len--)
    {
        //Get the next byte in the stream.
        data=*bufptr++;
        //Push this byte's bits through a software
        //implementation of a hardware shift & xor.
        for(bit_count=0;bit_count<=7;bit_count++)
        {
            //Shift the CRC accumulator
            newCRC>>=1;

            //The new MSB of the CRC accumulator comes
            //from the LSB of the current data byte.
            if(data&0x01)
                newCRC|=0x00800000;

            //If the low bit of the current CRC accumulator was set
            //before the shift, then we need to XOR the accumulator
            //with the polynomial (center 16 bits of 0x00840800)
            if(newCRC&0x00000080)
                newCRC^=0x00840800;
            //Shift the data byte to put the next bit of the stream
            //into position 0.
            data>>=1;
        }
    }

    //All the data has been done. Do 16 more bits of 0 data.
    for(bit_count=0;bit_count<=15;bit_count++)
    {
        //Shift the CRC accumulator
        newCRC>>=1;
    }
}
```





```

//If the low bit of the current CRC accumulator was set
//before the shift we need to XOR the accumulator with
//0x00840800.
if(newCRC&0x00000080)
    newCRC^=0x00840800;
}
//Return the center 16 bits, making this CRC match the one's
//complement that is sent in the packet.
return((~newCRC)>>8);
}

```

### ALGORITHM 3: "PIC ASSEMBLY" BIT SHIFT IMPLEMENTATION

This routine was graciously donated by one of our customers.

```

;=====
; CrystalFontz CFA-631 PIC CRC Calculation Example
;
; This example calculates the CRC for the hard coded example provided
; in the documentation.
;
; It uses "This is a test. " as input and calculates the proper CRC
; of 0x93FA.
;=====
#include "p16f877.inc"
;=====
; CRC16 equates and storage
;-----
accuml    equ    40h        ; BYTE - CRC result register high byte
accumh    equ    41h        ; BYTE - CRC result register high low byte
datareg   equ    42h        ; BYTE - data register for shift
j         equ    43h        ; BYTE - bit counter for CRC 16 routine
Zero      equ    44h        ; BYTE - storage for string memory read
index     equ    45h        ; BYTE - index for string memory read
savchr    equ    46h        ; BYTE - temp storage for CRC routine
;
seedlo    equ    021h       ; initial seed for CRC reg lo byte
seedhi    equ    0F3h       ; initial seed for CRC reg hi byte
;
polyL     equ    008h       ; polynomial low byte
polyH     equ    084h       ; polynomial high byte
;=====
; CRC Test Program
;-----
        org      0          ; reset vector = 0000H
;
        clrf     PCLATH     ; ensure upper bits of PC are cleared
        clrf     STATUS     ; ensure page bits are cleared
        goto    main       ; jump to start of program
;
; ISR Vector
;
        org      4          ; start of ISR
        goto    $          ; jump to ISR when coded
;
        org      20         ; start of main program
main
        movlw   seedhi      ; setup initial CRC seed value.
        movwf   accumh      ; This must be done prior to
        movlw   seedlo      ; sending string to CRC routine.
        movwf   accuml      ;
        clrf    index       ; clear string read variables
;
main1
        movlw   HIGH InputStr ; point to LCD test string
        movwf   PCLATH      ; latch into PCL

```



```

    movfw      index      ; get index
    call       InputStr   ; get character
    movwf     Zero       ; setup for terminator test
    movf      Zero,f      ; see if terminator
    btfsc     STATUS,Z    ; skip if not terminator
    goto      main2      ; else terminator reached, jump out of loop
    call      CRC16       ; calculate new crc
    call      SENDUART    ; send data to LCD
    incf     index,f      ; bump index
    goto     main1       ; loop

;
main2
    movlw     00h         ; shift accumulator 16 more bits.
    call     CRC16       ; This must be done after sending
    movlw     00h         ; string to CRC routine.
    call     CRC16       ;
;
    comf     accumh,f    ; invert result
    comf     accuml,f    ;
;
    movfw     accuml     ; get CRC low byte
    call     SENDUART    ; send to LCD
    movfw     accumh     ; get CRC hi byte
    call     SENDUART    ; send to LCD
;
stop    goto    stop      ; word result of 0x93FA is in accumh/accuml
;=====
; calculate CRC of input byte
;-----
CRC16
    movwf     savchr     ; save the input character
    movwf     datareg    ; load data register
    movlw     .8         ; setup number of bits to test
    movwf     j          ; save to incrementor
_loop
    clrc      ; clear carry for CRC register shift
    rrf      datareg,f   ; perform shift of data into CRC register
    rrf      accumh,f   ;
    rrf      accuml,f   ;
    btfss    STATUS,C   ; skip jump if if carry
    goto     _notset    ; otherwise goto next bit
    movlw    polyL      ; XOR poly mask with CRC register
    xorwf   accuml,F    ;
    movlw    polyH      ;
    xorwf   accumh,F    ;
_notset
    decfsz   j,F        ; decrement bit counter
    goto     _loop      ; loop if not complete
    movfw    savchr     ; restore the input character
    return   ; return to calling routine
;=====
; USER SUPPLIED Serial port transmit routine
;-----
SENDUART
    return      ; put serial xmit routine here
;=====
; test string storage
;-----
    org      0100h
;
InputStr
    addwf    PCL,f
    dt      7h,10h,"This is a test. ",0
;
;=====
end

```



## ALGORITHM 4: “VISUAL BASIC” TABLE IMPLEMENTATION

Visual BASIC has its own challenges as a language (such as initializing static arrays), and it is also challenging to use Visual BASIC to work with “binary” (arbitrary length character data possibly containing nulls—such as the “data” portion of the CFA-631 packet) data. This routine was adapted from the C table implementation. The complete project can be found in our forums.

```
'This program is brutally blunt. Just like VB. No apologies.
'Written by CrystalFontz America, Inc. 2004 http://www.crystalfontz.com
'Free code, not copyright copyleft or anything else.
'Some visual basic concepts taken from:
'http://www.planet-source-code.com/vb/scripts/ShowCode.asp?txtCodeId=21434&lngWid=1
'most of the algorithm is from functions in 631_WinTest:
'http://www.crystalfontz.com/products/631/631_WinTest.zip
'Full zip of the project is available in our forum:
'http://www.crystalfontz.com/forum/showthread.php?postid=9921#post9921

Private Type WORD
    Lo As Byte
    Hi As Byte
End Type

Private Type PACKET_STRUCT
    command As Byte
    data_length As Byte
    data(22) As Byte
    crc As WORD
End Type

Dim crcLookupTable(256) As WORD

Private Sub MSComm_OnComm()
'Leave this here
End Sub

'My understanding of visual basic is very limited--however it appears that there is no way
'to initialize an array of structures. Nice language. Fast processors, lots of memory, big
'disks, and we fill them up with this . . this . . this . . STUFF.
Sub Initialize_CRC_Lookup_Table()
    crcLookupTable(0).Lo = &H0
    crcLookupTable(0).Hi = &H0
    . . .
'For purposes of brevity in this data sheet, I have removed 251 entries of this table, the
'full source is available in our forum:
'http://www.crystalfontz.com/forum/showthread.php?postid=9921#post9921
    . . .
    crcLookupTable(255).Lo = &H78
    crcLookupTable(255).Hi = &HF
End Sub

'This function returns the CRC of the array at data for length positions
Private Function Get_CRC(ByRef data() As Byte, ByVal length As Integer) As WORD
    Dim Index As Integer
    Dim Table_Index As Integer
    Dim newCrc As WORD
    newCrc.Lo = &HFF
    newCrc.Hi = &HFF
    For Index = 0 To length - 1
        'exclusive-or the input byte with the low-order byte of the CRC register
        'to get an index into crcLookupTable
        Table_Index = newCrc.Lo Xor data(Index)
        'shift the CRC register eight bits to the right
        newCrc.Lo = newCrc.Hi
        newCrc.Hi = 0
        ' exclusive-or the CRC register with the contents of Table at Table_Index
        newCrc.Lo = newCrc.Lo Xor crcLookupTable(Table_Index).Lo
        newCrc.Hi = newCrc.Hi Xor crcLookupTable(Table_Index).Hi
    
```



```
Next Index
'Invert & return newCrc
Get_Crc.Lo = newCrc.Lo Xor &HFF
Get_Crc.Hi = newCrc.Hi Xor &HFF
End Function

Private Sub Send_Packet(ByRef packet As PACKET_STRUCT)
Dim Index As Integer
'Need to put the whole packet into a linear array
'since you can't do type overrides. VB, gotta love it.
Dim linear_array(26) As Byte
linear_array(0) = packet.command
linear_array(1) = packet.data_length
For Index = 0 To packet.data_length - 1
    linear_array(Index + 2) = packet.data(Index)
Next Index
packet.crc = Get_Crc(linear_array, packet.data_length + 2)
'Might as well move the CRC into the linear array too
linear_array(packet.data_length + 2) = packet.crc.Lo
linear_array(packet.data_length + 3) = packet.crc.Hi
'Now a simple loop can dump it out the port.
For Index = 0 To packet.data_length + 3
    MSComm.Output = Chr(linear_array(Index))
Next Index
End Sub
```

## ALGORITHM 5: “JAVA” TABLE IMPLEMENTATION

This [code was posted in our forum](#) by user “norm” as a working example of a Java CRC calculation.

```
public class CRC16 extends Object
{
    public static void main(String[] args)
    {
        byte[] data = new byte[2];
        // hw - fw
        data[0] = 0x01;
        data[1] = 0x00;
        System.out.println("hw -fw req");
        System.out.println(Integer.toHexString(compute(data)));

        // ping
        data[0] = 0x00;
        data[1] = 0x00;
        System.out.println("ping");
        System.out.println(Integer.toHexString(compute(data)));

        // reboot
        data[0] = 0x05;
        data[1] = 0x00;
        System.out.println("reboot");
        System.out.println(Integer.toHexString(compute(data)));

        // clear lcd
        data[0] = 0x06;
        data[1] = 0x00;
        System.out.println("clear lcd");
        System.out.println(Integer.toHexString(compute(data)));

        // set line 1
        data = new byte[18];
        data[0] = 0x07;
        data[1] = 0x10;
        String text = "Test Test Test ";
        byte[] textByte = text.getBytes();
        for (int i=0; i < text.length(); i++) data[i+2] = textByte[i];
        System.out.println("text 1");
    }
}
```



```

    System.out.println(Integer.toHexString(compute(data)));
}
private CRC16()
{
}
private static final int[] crcLookupTable =
{
    0x00000, 0x01189, 0x02312, 0x0329B, 0x04624, 0x057AD, 0x06536, 0x074BF,
    0x08C48, 0x09DC1, 0x0AF5A, 0x0BED3, 0x0CA6C, 0x0DBE5, 0x0E97E, 0x0F8F7,
    0x01081, 0x00108, 0x03393, 0x0221A, 0x056A5, 0x0472C, 0x075B7, 0x0643E,
    0x09CC9, 0x08D40, 0x0BFDB, 0x0AE52, 0x0DAED, 0x0CB64, 0x0F9FF, 0x0E876,
    0x02102, 0x0308B, 0x00210, 0x01399, 0x06726, 0x076AF, 0x04434, 0x055BD,
    0x0AD4A, 0x0BCC3, 0x08E58, 0x09FD1, 0x0EB6E, 0x0FAE7, 0x0C87C, 0x0D9F5,
    0x03183, 0x0200A, 0x01291, 0x00318, 0x077A7, 0x0662E, 0x054B5, 0x0453C,
    0x0BDCB, 0x0AC42, 0x09ED9, 0x08F50, 0x0FBEF, 0x0EA66, 0x0D8FD, 0x0C974,
    0x04204, 0x0538D, 0x06116, 0x0709F, 0x00420, 0x015A9, 0x02732, 0x036BB,
    0x0CE4C, 0x0DFC5, 0x0ED5E, 0x0FCD7, 0x08868, 0x099E1, 0x0AB7A, 0x0BAF3,
    0x05285, 0x0430C, 0x07197, 0x0601E, 0x014A1, 0x00528, 0x037E3, 0x0263A,
    0x0DECD, 0x0CF44, 0x0FDDF, 0x0EC56, 0x098E9, 0x08960, 0x0BBFB, 0x0AA72,
    0x06306, 0x0728F, 0x04014, 0x0519D, 0x02522, 0x034AB, 0x00630, 0x017B9,
    0x0EF4E, 0x0FEC7, 0x0CC5C, 0x0DDD5, 0x0A96A, 0x0B8E3, 0x08A78, 0x09BF1,
    0x07387, 0x0620E, 0x05095, 0x0411C, 0x035A3, 0x0242A, 0x016B1, 0x00738,
    0x0FFCF, 0x0EE46, 0x0DCDD, 0x0CD54, 0x0B9EB, 0x0A862, 0x09AF9, 0x08B70,
    0x08408, 0x09581, 0x0A71A, 0x0B693, 0x0C22C, 0x0D3A5, 0x0E13E, 0x0F0B7,
    0x00840, 0x019C9, 0x02B52, 0x03ADB, 0x04E64, 0x05FED, 0x06D76, 0x07CFF,
    0x09489, 0x08500, 0x0B79B, 0x0A612, 0x0D2AD, 0x0C324, 0x0F1BF, 0x0E036,
    0x018C1, 0x00948, 0x03BD3, 0x02A5A, 0x05EE5, 0x04F6C, 0x07DF7, 0x06C7E,
    0x0A50A, 0x0B483, 0x08618, 0x09791, 0x0E32E, 0x0F2A7, 0x0C03C, 0x0D1B5,
    0x02942, 0x038CB, 0x00A50, 0x01BD9, 0x06F66, 0x07EEF, 0x04C74, 0x05DFD,
    0x0B58B, 0x0A402, 0x09699, 0x08710, 0x0F3AF, 0x0E226, 0x0D0BD, 0x0C134,
    0x039C3, 0x0284A, 0x01AD1, 0x00B58, 0x07FE7, 0x06E6E, 0x05CF5, 0x04D7C,
    0x0C60C, 0x0D785, 0x0E51E, 0x0F497, 0x08028, 0x091A1, 0x0A33A, 0x0B2B3,
    0x04A44, 0x05BCD, 0x06956, 0x078DF, 0x00C60, 0x01DE9, 0x02F72, 0x03EFB,
    0x0D68D, 0x0C704, 0x0F59F, 0x0E416, 0x090A9, 0x08120, 0x0B3BB, 0x0A232,
    0x05AC5, 0x04B4C, 0x079D7, 0x0685E, 0x01CE1, 0x00D68, 0x03FF3, 0x02E7A,
    0x0E70E, 0x0F687, 0x0C41C, 0x0D595, 0x0A12A, 0x0B0A3, 0x08238, 0x093B1,
    0x06B46, 0x07ACF, 0x04854, 0x059DD, 0x02D62, 0x03CEB, 0x00E70, 0x01FF9,
    0x0F78F, 0x0E606, 0x0D49D, 0x0C514, 0x0B1AB, 0x0A022, 0x092B9, 0x08330,
    0x07BC7, 0x06A4E, 0x058D5, 0x0495C, 0x03DE3, 0x02C6A, 0x01EF1, 0x00F78
};
public static int compute(byte[] data)
{
    int newCrc = 0xFFFF;
    for (int i = 0; i < data.length; i++)
    {
        int lookup = crcLookupTable[(newCrc ^ data[i]) & 0xFF];
        newCrc = (newCrc >> 8) ^ lookup;
    }
    return(~newCrc);
}
}

```

## ALGORITHM 6: “PERL” TABLE IMPLEMENTATION

This code was translated from the C version by one of our customers.

```

#!/usr/bin/perl

use strict;

my @CRC_LOOKUP =
(0x00000, 0x01189, 0x02312, 0x0329B, 0x04624, 0x057AD, 0x06536, 0x074BF,
0x08C48, 0x09DC1, 0x0AF5A, 0x0BED3, 0x0CA6C, 0x0DBE5, 0x0E97E, 0x0F8F7,
0x01081, 0x00108, 0x03393, 0x0221A, 0x056A5, 0x0472C, 0x075B7, 0x0643E,
0x09CC9, 0x08D40, 0x0BFDB, 0x0AE52, 0x0DAED, 0x0CB64, 0x0F9FF, 0x0E876,
0x02102, 0x0308B, 0x00210, 0x01399, 0x06726, 0x076AF, 0x04434, 0x055BD,
0x0AD4A, 0x0BCC3, 0x08E58, 0x09FD1, 0x0EB6E, 0x0FAE7, 0x0C87C, 0x0D9F5,

```



```
0x03183,0x0200A,0x01291,0x00318,0x077A7,0x0662E,0x054B5,0x0453C,
0x0BDCB,0x0AC42,0x09ED9,0x08F50,0x0FBF7,0x0EA66,0x0D8FD,0x0C974,
0x04204,0x0538D,0x06116,0x0709F,0x00420,0x015A9,0x02732,0x036BB,
0x0CE4C,0x0DFC5,0x0ED5E,0x0FCD7,0x08868,0x099E1,0x0AB7A,0x0BAF3,
0x05285,0x0430C,0x07197,0x0601E,0x014A1,0x00528,0x037B3,0x0263A,
0x0DECD,0x0CF44,0x0FDDF,0x0EC56,0x098E9,0x08960,0x0BBFB,0x0AA72,
0x06306,0x0728F,0x04014,0x0519D,0x02522,0x034AB,0x00630,0x017B9,
0x0EF4E,0x0FEC7,0x0CC5C,0x0DDD5,0x0A96A,0x0B8E3,0x08A78,0x09BF1,
0x07387,0x0620E,0x05095,0x0411C,0x035A3,0x0242A,0x016B1,0x00738,
0x0FFCF,0x0EE46,0x0DCDD,0x0CD54,0x0B9EB,0x0A862,0x09AF9,0x08B70,
0x08408,0x09581,0x0A71A,0x0B693,0x0C22C,0x0D3A5,0x0E13E,0x0F0B7,
0x00840,0x019C9,0x02B52,0x03ADB,0x04E64,0x05FED,0x06D76,0x07CFF,
0x09489,0x08500,0x0B79B,0x0A612,0x0D2AD,0x0C324,0x0F1BF,0x0E036,
0x018C1,0x00948,0x03BD3,0x02A5A,0x05EE5,0x04F6C,0x07DF7,0x06C7E,
0x0A50A,0x0B483,0x08618,0x09791,0x0E32E,0x0F2A7,0x0C03C,0x0D1B5,
0x02942,0x038CB,0x00A50,0x01BD9,0x06F66,0x07EEF,0x04C74,0x05DFD,
0x0B58B,0x0A402,0x09699,0x08710,0x0F3AF,0x0E226,0x0D0BD,0x0C134,
0x039C3,0x0284A,0x01AD1,0x00B58,0x07FE7,0x06E6E,0x05CF5,0x04D7C,
0x0C60C,0x0D785,0x0E51E,0x0F497,0x08028,0x091A1,0x0A33A,0x0B2B3,
0x04A44,0x05BCD,0x06956,0x078DF,0x00C60,0x01DE9,0x02F72,0x03EFB,
0x0D68D,0x0C704,0x0F59F,0x0E416,0x090A9,0x08120,0x0B3BB,0x0A232,
0x05AC5,0x04B4C,0x079D7,0x0685E,0x01CE1,0x00D68,0x03FF3,0x02E7A,
0x0E70E,0x0F687,0x0C41C,0x0D595,0x0A12A,0x0B0A3,0x08238,0x093B1,
0x06B46,0x07ACF,0x04854,0x059DD,0x02D62,0x03CEB,0x00E70,0x01FF9,
0x0F78F,0x0E606,0x0D49D,0x0C514,0x0B1AB,0x0A022,0x092B9,0x08330,
0x07BC7,0x06A4E,0x058D5,0x0495C,0x03DE3,0x02C6A,0x01EF1,0x00F78);
```

```
# our test packet read from an enter key press over the serial line:
# type = 80 (key press)
# data_length = 1 (1 byte of data)
# data = 5
```

```
my $type = '80';
my $length = '01';
my $data = '05';
```

```
my $packet = $type . $length . $data ;
```

```
my $valid_crc = '5584' ;
```

```
print "A CRC of Packet ($packet) Should Equal ($valid_crc)\n";
```

```
my $crc = 0xFFFF ;
```

```
printf("%x\n", $crc);
```

```
foreach my $char (split //, $packet)
```

```
{
  # newCrc = (newCrc >> 8) ^ crcLookupTable[(newCrc ^ *bufptr++) & 0xff];
  # & is bitwise AND
  # ^ is bitwise XOR
  # >> bitwise shift right
  $crc = ($crc >> 8) ^ $CRC_LOOKUP[( $crc ^ ord($char) ) & 0xFF] ;
  # print out the running crc at each byte
  printf("%x\n", $crc);
}
```

```
# get the complement
$crc = ~$crc ;
$crc = ($crc & 0xFFFF) ;
```

```
# print out the crc in hex
printf("%x\n", $crc);
```



# APPENDIX D: QUALITY ASSURANCE STANDARDS

---

## INSPECTION CONDITIONS

- Environment
  - Temperature:  $25\pm 5^{\circ}\text{C}$
  - Humidity: 30~85% RH
- For visual inspection of active display area
  - Source lighting: two 20 Watt or one 40 Watt fluorescent light
  - Display adjusted for best contrast
  - Viewing distance:  $30\pm 5$  cm (about 12 inches)
  - Viewable angle: inspect at  $45^{\circ}$  angle of vertical line right and left, top and bottom

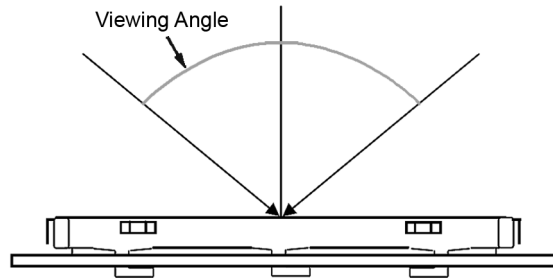

## DEFINITION OF ACTIVE DISPLAY AREA AND VIEWABLE AREA

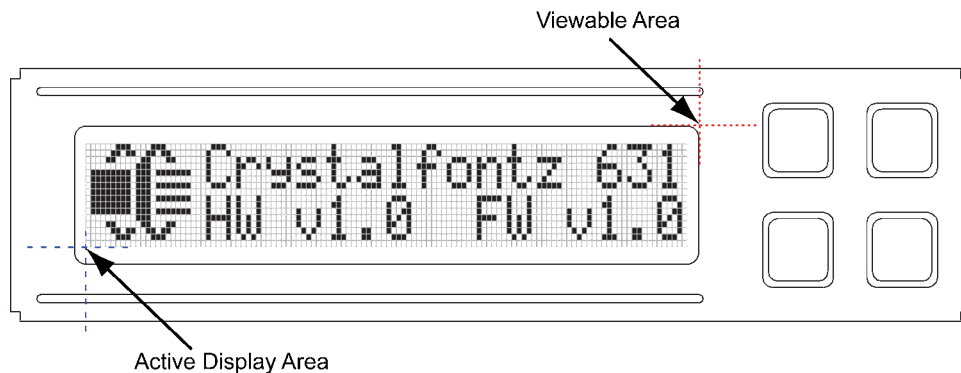



## ACCEPTANCE SAMPLING

DEFECT TYPE	AQL*
Major	≤0.65%
Minor	≤1.00%
*Acceptable Quality Level: maximum allowable error rate or variation from standard	

## DEFECTS CLASSIFICATION

Defects are defined as:

- Major Defect: results in failure or substantially reduces usability of unit for its intended purpose
- Minor Defect: deviates from standards but is not likely to reduce usability for its intended purpose

## ACCEPTANCE STANDARDS

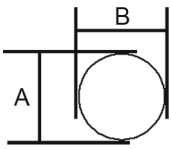
#	DEFECT TYPE	CRITERIA		MAJOR / MINOR	
1	Electrical defects	1. No display, display malfunctions, or shorted segments. 2. Current consumption exceeds specifications.		Major	
2	Viewing area defect	Viewing area does not meet specifications. (See <a href="#">Inspection Conditions (Pg. 55)</a> ).		Major	
3	Contrast adjustment defect	Contrast adjustment fails or malfunctions.		Major	
4	Blemishes or foreign matter on display segments		<i>Defect Size (mm)</i>	<i>Acceptable Qty</i>	Minor
			≤0.3	3	
			≤2 defects within 10 mm of each other		
5	Other blemishes or foreign matter outside of display segments	Defect size = (A + B)/2 	<i>Defect Size (mm)</i>	<i>Acceptable Qty</i>	Minor
			≤0.15	Ignore	
			0.15 to 0.20	3	
			0.20 to 0.25	2	
			0.25 to 0.30	1	



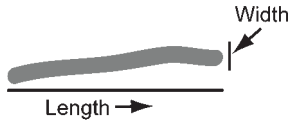
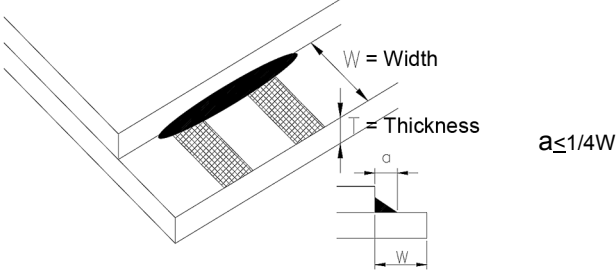
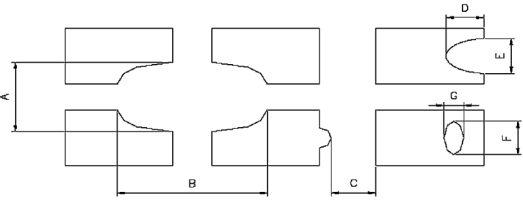

#	DEFECT TYPE	CRITERIA			MAJOR / MINOR
6	Dark lines or scratches in display area  	<i>Defect Width (mm)</i>	<i>Defect Length (mm)</i>	<i>Acceptable Qty</i>	Minor
		$\leq 0.03$	$\leq 3.0$	3	
		0.03 to 0.05	$\leq 2.0$	2	
		0.05 to 0.08	$\leq 2.0$	1	
		0.08 to 0.10	$\leq 3.0$	0	
		$\geq 0.10$	$> 3.0$	0	
7	Bubbles between polarizer film and glass	<i>Defect Size (mm)</i>	<i>Acceptable Qty</i>	Minor	
		$\leq 0.20$	Ignore		
		0.20 to 0.40	3		
		0.40 to 0.60	2		
		$\geq 0.60$	0		
8	Glass rest defect				Minor
9	Display pattern defect				Minor
		<i>Dot Size (mm)</i>	<i>Acceptable Qty</i>		
		$((A+B)/2) \leq 0.2$	$\leq 3$ total defects $\leq 2$ pinholes per digit		
		$C > 0$			
		$((D+E)/2) \leq 0.25$			
$((F+G)/2) \leq 0.25$					



#	DEFECT TYPE	CRITERIA	MAJOR / MINOR												
10	Chip in corner		Minor												
		<table border="1"> <thead> <tr> <th><i>a</i></th> <th><i>b</i></th> <th><i>c</i></th> <th>Acceptable Qty</th> </tr> </thead> <tbody> <tr> <td>&lt;4 mm</td> <td><math>\leq W</math></td> <td><math>c \leq T</math></td> <td>3</td> </tr> </tbody> </table>		<i>a</i>	<i>b</i>	<i>c</i>	Acceptable Qty	<4 mm	$\leq W$	$c \leq T$	3				
		<i>a</i>		<i>b</i>	<i>c</i>	Acceptable Qty									
<4 mm	$\leq W$	$c \leq T$	3												
11	Chip on "non-contact" edge of LCD		Minor												
		<table border="1"> <thead> <tr> <th><i>a</i></th> <th><i>b</i></th> <th><i>c</i></th> <th>Acceptable Qty</th> </tr> </thead> <tbody> <tr> <td><math>\leq 3</math> mm</td> <td><math>\leq 1</math> mm</td> <td><math>\leq T</math></td> <td>Ignore</td> </tr> <tr> <td><math>\leq 4</math> mm</td> <td><math>\leq 1.5</math> mm</td> <td><math>\leq T</math></td> <td>3</td> </tr> </tbody> </table>		<i>a</i>	<i>b</i>	<i>c</i>	Acceptable Qty	$\leq 3$ mm	$\leq 1$ mm	$\leq T$	Ignore	$\leq 4$ mm	$\leq 1.5$ mm	$\leq T$	3
		<i>a</i>		<i>b</i>	<i>c</i>	Acceptable Qty									
		$\leq 3$ mm		$\leq 1$ mm	$\leq T$	Ignore									
$\leq 4$ mm	$\leq 1.5$ mm	$\leq T$	3												
12	Chip on "contact" edge of LCD, on the active side		Minor												
		<table border="1"> <thead> <tr> <th><i>a</i></th> <th><i>b</i></th> <th><i>c</i></th> <th>Acceptable Qty</th> </tr> </thead> <tbody> <tr> <td><math>\leq 2</math> mm</td> <td><math>\leq W/4</math></td> <td><math>\leq T</math></td> <td>Ignore</td> </tr> <tr> <td><math>\leq 3</math> mm</td> <td><math>\leq W/4</math></td> <td><math>\leq T</math></td> <td>3</td> </tr> </tbody> </table>		<i>a</i>	<i>b</i>	<i>c</i>	Acceptable Qty	$\leq 2$ mm	$\leq W/4$	$\leq T$	Ignore	$\leq 3$ mm	$\leq W/4$	$\leq T$	3
		<i>a</i>		<i>b</i>	<i>c</i>	Acceptable Qty									
		$\leq 2$ mm		$\leq W/4$	$\leq T$	Ignore									
$\leq 3$ mm	$\leq W/4$	$\leq T$	3												



#	DEFECT TYPE	CRITERIA	MAJOR / MINOR												
13	Chip on "contact" edge of LCD, on the inactive side		Minor												
		<table border="1"> <thead> <tr> <th>a</th> <th>b</th> <th>c</th> <th>Acceptable Qty</th> </tr> </thead> <tbody> <tr> <td>≤3 mm</td> <td>≤1 mm</td> <td>≤T</td> <td>Ignore</td> </tr> <tr> <td>≤4 mm</td> <td>≤1.5 mm</td> <td>≤T</td> <td>3</td> </tr> </tbody> </table>		a	b	c	Acceptable Qty	≤3 mm	≤1 mm	≤T	Ignore	≤4 mm	≤1.5 mm	≤T	3
		a		b	c	Acceptable Qty									
		≤3 mm		≤1 mm	≤T	Ignore									
≤4 mm	≤1.5 mm	≤T	3												
<table border="1"> <thead> <tr> <th>a</th> <th>b</th> <th>c</th> <th>Acceptable Qty</th> </tr> </thead> <tbody> <tr> <td>&lt;3 mm</td> <td>≤1.5 mm</td> <td>≤1/2 T</td> <td>3</td> </tr> </tbody> </table>	a	b	c	Acceptable Qty	<3 mm	≤1.5 mm	≤1/2 T	3							
a	b	c	Acceptable Qty												
<3 mm	≤1.5 mm	≤1/2 T	3												
Unacceptable if c > 50% of glass thickness or if the seal area is damaged.															
14	Chip in seal area	<p>a = length  b = width  c = thickness</p>	Minor												
		<table border="1"> <thead> <tr> <th>a</th> <th>b</th> <th>c</th> <th>Acceptable Qty</th> </tr> </thead> <tbody> <tr> <td>&lt;3 mm</td> <td>≤1.5 mm</td> <td>≤1/2 T</td> <td>3</td> </tr> </tbody> </table>		a	b	c	Acceptable Qty	<3 mm	≤1.5 mm	≤1/2 T	3				
		a		b	c	Acceptable Qty									
<3 mm	≤1.5 mm	≤1/2 T	3												
Unacceptable if c > 50% of glass thickness or if the seal area is damaged.															
15	Backlight defects	<ol style="list-style-type: none"> <li>1. Light fails or flickers. (Major)</li> <li>2. Color and luminance do not correspond to specifications. (Major)</li> <li>3. Exceeds standards for display's blemishes or foreign matter (<a href="#">see test 5, page 56</a>), and dark lines or scratches (<a href="#">see test 6, page 57</a>). (Minor)</li> </ol>	See list												
16	COB defects	<ol style="list-style-type: none"> <li>1. Pinholes &gt; 0.2 mm.</li> <li>2. Seal surface has pinholes through to the IC.</li> <li>3. More than 3 locations of sealant beyond 2 mm of the sealed areas.</li> </ol>	Minor												
17	PCB defects	<ol style="list-style-type: none"> <li>1. Oxidation or contamination on connectors.*</li> <li>2. Wrong parts, missing parts, or parts not in specification.*</li> <li>3. Jumpers set incorrectly. (Minor)</li> <li>4. Solder (if any) on bezel, LED pad, zebra pad, or screw hole pad is not smooth. (Minor)</li> </ol> <p>*Minor if display functions correctly. Major if the display fails.</p>	See list												



#	DEFECT TYPE	CRITERIA	MAJOR / MINOR
18	Soldering defects	1. Unmelted solder paste. 2. Cold solder joints, missing solder connections, or oxidation.* 3. Solder bridges causing short circuits.* 4. Residue or solder balls. 5. Solder flux is black or brown. *Minor if display functions correctly. Major if the display fails.	Minor